

# HB-Therm<sup>®</sup> THERMO-5

## Instruction Manual HB-100/140/160/180Z3

Temperature Control Unit



HB-Therm AG  
Piccardstrasse 6  
9015 St. Gallen  
SWITZERLAND

[www.hb-therm.com](http://www.hb-therm.com)

E-Mail [info@hb-therm.ch](mailto:info@hb-therm.ch)  
Phone +41 71 243 65 30

Translation of original instruction

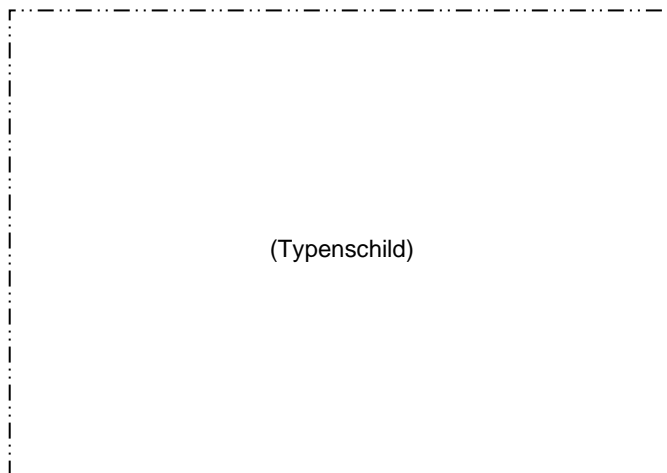

<b>Index</b> .....	<b>7</b>
<b>1 General</b> .....	<b>9</b>
1.1 Information about this manual .....	9
1.2 Explanation of symbols .....	10
1.3 Limitation of liability .....	11
1.4 Copyright .....	11
1.5 Warranty terms .....	12
1.6 Customer Service .....	12
<b>2 Safety</b> .....	<b>13</b>
2.1 Intended Use .....	13
2.2 Customer's responsibility .....	14
2.3 Personnel requirements .....	15
2.3.1 Qualifications.....	15
2.3.2 Unauthorized persons.....	16
2.4 Personal protective equipment.....	17
2.5 Specific dangers .....	18
2.6 Safety devices .....	20
2.7 Stickers and decals .....	21
2.8 CE Declaration of Conformity for Machinery .....	22
2.9 UK Declaration of Conformity for Machinery .....	23
<b>3 Technical data</b> .....	<b>24</b>
3.1 General Information.....	24
3.2 Emissions .....	25
3.3 Operating conditions .....	25
3.4 Connection values .....	26
3.5 Operating fluids .....	28
3.6 Nameplate .....	29
<b>4 Structure and function</b> .....	<b>30</b>
4.1 Overview.....	30
4.2 Brief description.....	30
4.3 Functional principle .....	31
4.4 Heat transfer medium .....	31
4.5 Connections.....	32
4.6 Additional equipment .....	33
4.7 Operation modes .....	34
4.7.1 Main operating modes .....	34
4.7.2 Auxiliary modes.....	34
4.8 Work and danger zones .....	34
<b>5 Transport, packing and storage</b> .....	<b>35</b>
5.1 Safety notes for transport .....	35
5.2 Transport .....	35
5.3 Transport inspection .....	37
5.4 Packing.....	37

## Contents

5.5	Symbols on the packing .....	39
5.6	Storage .....	39
<b>6</b>	<b>Installation and initial commissioning .....</b>	<b>40</b>
6.1	Safety .....	40
6.2	Requirements for the installation location .....	41
6.3	Installation work.....	42
6.3.1	Lock castors .....	42
6.3.2	Water treatment .....	42
6.3.3	Set the separate connection for system water .....	43
6.3.4	Setting up system connections .....	44
6.3.5	Connect data interfaces .....	46
6.3.6	Connect external sensor .....	48
<b>7</b>	<b>Control.....</b>	<b>49</b>
7.1	Keyboard .....	49
7.1.1	Key functions on an individual unit .....	49
7.1.2	Key functions and operation on an individual unit .....	50
7.1.3	Key functions on unit operated as module.....	51
7.1.4	Basic display .....	52
7.2	Operating structure.....	54
7.3	Menu structure.....	55
<b>8</b>	<b>Operation .....</b>	<b>64</b>
8.1	Mains ON.....	64
8.2	Registering new modular units .....	65
8.3	Special features for operation of modular units.....	66
8.4	Operate singular unit as modular unit .....	67
8.5	Switching on .....	68
8.5.1	Normal operation .....	68
8.5.2	External sensor .....	69
8.5.3	Mode 2nd nominal value.....	71
8.5.4	Remote mode.....	72
8.6	Switching off .....	75
8.6.1	Cooling down and switching off .....	76
8.6.2	Mould evacuation .....	77
8.6.3	Mould evacuation with compressed air.....	78
8.7	Emergency stop.....	79
8.8	Define access rights .....	80
8.8.1	Set user profile .....	80
8.8.2	Set operating release .....	81
8.8.3	Change access code .....	82
8.9	Settings.....	83
8.9.1	Setting time zone, date and time .....	83
8.9.2	Define internal measuring points .....	84
8.9.3	Set switch clock .....	85
8.9.4	Set ramp programme .....	86

## Contents

	8.9.5	Cyclical change-out of the system water ...	88
8.10		Process monitoring.....	89
	8.10.1	Limit value monitoring.....	89
	8.10.2	Monitor pump wear .....	91
	8.10.3	Optimise controller .....	92
8.11		Explorer window .....	93
8.12		Save/Load .....	94
	8.12.1	Tool data .....	96
	8.12.2	Recording actual data .....	98
<b>9</b>		<b>Maintenance.....</b>	<b>100</b>
	9.1	Safety .....	100
	9.2	Open the unit.....	101
	9.3	Maintenance schedule .....	103
	9.4	Maintenance tasks .....	105
	9.4.1	Cleaning.....	105
	9.4.2	Pump.....	106
	9.4.3	Temperature measurement .....	107
	9.4.4	Pressure measurement.....	108
	9.4.5	Safety valve.....	108
	9.4.6	Software update .....	109
	9.4.7	Gain access to components.....	111
<b>10</b>		<b>Faults.....</b>	<b>113</b>
	10.1	Safety .....	113
	10.2	Fault indications.....	115
	10.2.1	Fault indication display.....	115
	10.3	Determine the cause of a fault .....	116
	10.4	Troubleshooting chart.....	117
	10.5	Startup after eliminating fault.....	119
<b>11</b>		<b>Disposal .....</b>	<b>120</b>
	11.1	Safety .....	120
	11.2	Disposal of materials .....	120
<b>12</b>		<b>Spare parts.....</b>	<b>121</b>
	12.1	Ordering spare parts .....	121
<b>13</b>		<b>Technical information .....</b>	<b>122</b>
	13.1	Electrical circuit diagram .....	122
	13.2	Hydraulic scheme .....	128
	13.3	Item location .....	129
	13.4	Legend.....	132
<b>14</b>		<b>Interface cables .....</b>	<b>134</b>
	14.1	External sensor.....	134
	14.2	External control.....	135
	14.3	Serial data interfaces.....	135
	14.4	CAN-Bus interfaces .....	137
	14.5	Interface HB.....	138

## Contents

### Appendix

- A Special execution
- B Spare parts list

## Index

### A

Access code .....	82
Access rights .....	80
Additional equipment .....	33

### B

Basic display .....	52
---------------------	----

### C

CE Declaration of Conformity .....	22
Cleaning.....	105
Code .....	82
Connect external sensor.....	48
Connect interfaces.....	46
Connection	
Cooling water .....	27
Drain.....	27
Electrical .....	32
Electrical .....	26
main and return line .....	27
separate system water.....	27
Connection values .....	26
Control .....	49
Controller optimisation .....	92
Cooling.....	76
Customer Service .....	12
Cyclical change-out of the system water .....	88

### D

Danger zones .....	34
dangers .....	18
Date, set .....	83
Disposal .....	120
Disposal of materials .....	120

### E

Electric current.....	18
Electrical circuit diagram.....	122
Emissions .....	25

### F

Faults .....	113
cause.....	116
indications .....	115
overview.....	116

Functional principle .....	31
----------------------------	----

### H

Heat transfer medium .....	31
Hydraulic connections.....	32
Hydraulic scheme .....	128
Hydraulic specialist .....	15

### I

Installation .....	42
Installation location .....	41
Intended Use.....	13
Interface cables.....	134
Item location.....	129

### K

Keyboard.....	49
---------------	----

### L

Legend .....	132
Liability .....	11
Lock castors.....	42
Logbook Alarms .....	116

### M

Main switch .....	20
Maintenance .....	100
schedule.....	103
tasks.....	105
Maximum fusing.....	26
Measurement	
flow rate.....	24
pressure .....	24
Temperature.....	24
Measuring points.....	84
Menu structure .....	55
Monitoring .....	89
level.....	90
limit values .....	89
Pump wear .....	91
Mould evacuation.....	77
compressed air.....	78

### N

Nameplate.....	29
----------------	----

Nominal value 2 .....	71	Spare parts .....	121
Normal operation .....	68	Special Design .....	9
<b>O</b>		Status display .....	53
Opening the unit .....	101	Stickers .....	21
Operating conditions .....	25	Storage .....	39
Operating fluids .....	28	Structure .....	30
Operating release .....	81	Surfaces, hot .....	19
Operating structure .....	54	Switch clock .....	85
Operation .....	64	Switching off .....	75
Operation modes .....	34	Switching on .....	68
Overview .....	30	Symbol display .....	53
<b>P</b>		Symbols	
Packing .....	37	in this manual .....	10
Personnel .....	15, 100, 113	Packing .....	39
Pressure measurement .....	108	rear of unit .....	32
Professional electrician .....	15	<b>T</b>	
Protective equipment .....	17, 100, 113	Technical data .....	24
Pump .....	106	Technical information .....	122
<b>Q</b>		Temperature measurement .....	107
Qualified personnel .....	15	Time, set .....	83
<b>R</b>		Tool data .....	96
Ramp programme .....	86	Transport .....	35
Recording actual data .....	98	Troubleshooting	
Remote mode .....	72	Chart .....	117
Residual current circuit-breaker (RCD) .....	26	<b>U</b>	
<b>S</b>		UK-Declaration of Conformity .....	23
Safety .....	13	Used for .....	13
Safety devices .....	20	User profile .....	80
Safety valve .....	108	<b>W</b>	
Save/Load .....	94	Warranty .....	12
Settings .....	83	Water treatment .....	42
Software update .....	109	Weight .....	24
Sound pressure level .....	25	Work zones .....	34
		Working materials .....	18



# 1 General

## 1.1 Information about this manual

This manual enables the safe and efficient handling of the unit.

The manual is a component part of the unit and must always be kept close to the unit readily accessible for personnel. Before starting any work, the personnel must have carefully read through and understood this manual. A basic requirement for safe work is the observance of all safety and handling instructions in this manual.

Furthermore, the local accident prevention regulations and general safety regulations are valid for the application area of the unit.

Illustrations in this manual serve the basic understanding and can deviate from the actual design of the unit.

For units with a special design (see the nameplate on the unit or on page 2), the corresponding additional documents are included in Appendix A.

We reserve the right to make technical modifications in order to improve usability.

## General

### 1.2 Explanation of symbols

#### Warnings

Warnings are identified by symbols. These warnings are introduced by signal words, which express the severity of a danger. Adhere to these warnings and act cautiously in order to avoid accidents, personal injuries and damage to property.



#### **DANGER!**

... indicates an imminently hazardous situation which, if not avoided, will result in death or serious injury.



#### **WARNING!**

... indicates a potentially hazardous situation which, if not avoided, could result in death or serious injury.



#### **CAUTION!**

... indicates a potentially hazardous situation which, if not avoided, may result in minor or moderate injury.



#### **ATTENTION!**

... indicates a potentially hazardous situation which, if not avoided, may result in property damage.

#### Hints and recommendations



#### **NOTE!**

... emphasizes useful hints and recommendations as well as information for efficient and trouble-free operation.

#### Special safety notes

The following symbols are used in connection with the safety notes to highlight particular dangers:



... highlights hazards caused by electric current. There is a danger of serious injury or death if the safety notes are not complied with.

### 1.3 Limitation of liability

All information and notes in this Manual were compiled under due consideration of valid standards and regulations, the present status of technology and our years of knowledge and experience.

The manufacturer can not be made liable for damage resulting from:

- disregarding this Manual
- unintended use
- employment of untrained personnel
- unauthorized conversions
- technical modifications
- use of unapproved spare parts

In case of customised versions the actual scope of delivery can vary from the explanations and representations in this Manual, because of the utilization of additional options or due to latest technical changes.

Apart from this, the obligations agreed upon in the delivery contract, the general terms and conditions and the delivery conditions of the manufacturer and the legal regulations valid at the time of contract do apply.

### 1.4 Copyright

This Manual is protected by copyright law and exclusively to be used for internal purposes.

Passing this Manual on to third parties, duplication of any kind – even in form of excerpts – as well as the use and/or disclosure of the contents without the written consent of the manufacturer is not permitted, except for internal purposes.

Violations oblige to compensation. The right for further claims remains reserved.

## General

### 1.5 Warranty terms

The warranty terms are provided in the manufacturer's terms and conditions.

### 1.6 Customer Service

For technical information, please contact the HB-Therm representatives or our customer service department  
→ [www.hb-therm.ch](http://www.hb-therm.ch).

Furthermore, our employees are always interested in new information and experiences resulting from the application that could be valuable for the improvement of our products.

## 2 Safety

This paragraph provides an overview of all important safety aspects for optimal protection of personnel as well as safe and trouble-free operation.

Disregarding this Manual and safety regulations specified therein may result in considerable danger.

### 2.1 Intended Use

The unit is designed and constructed exclusively for the intended use described here.

The temperature control unit serves exclusively to bring a connected consumer (for example a tool) to a specified temperature and to keep this constant by means of the heat transfer medium water and by heating and cooling.

The temperature control unit must only be operated in accordance with the values specified in the technical data.

Observance of all information in this manual also pertains to the intended use.

Any use of the unit other than or going beyond the intended use is deemed as misuse and can lead to dangerous situations.



**WARNING!**  
**Danger on misuse!**

Misuse of the unit can lead to dangerous situations.

In particular, refrain from the following applications of the unit:

- Use of a heat transfer medium other than water.

Claims of any nature regarding damage caused by improper use are excluded.

## Safety

### 2.2 Customer's responsibility

The device is implemented commercially. Thus the owner of the device is subject to legal industrial safety obligations.

In addition to the safety instructions in this Manual, the safety, accident prevention guidelines and environmental protection regulations, applicable at the site of implementation must be complied with. In particular:

- Owner must inform himself of applicable industrial safety regulations and determine additional hazards that arise due to the specific working conditions prevailing at the site where the device is implemented, in a risk analysis. The risk assessment must be implemented in the form of work instructions for device operation.
- Owner must check throughout the entire implementation period of the device, whether the work instructions that owner has created satisfy current legislation, and must adapt the instructions if necessary.
- Owner must clearly regulate and specify the responsibilities for installation, operation, maintenance, and cleaning.
- Owner must ensure that all employees who deal with the device have read and understood this Manual.  
In addition, owner must train personnel at regular intervals and inform personnel of the hazards.
- Owner must provide personnel with the required protective equipment.

In addition, owner is responsible to ensure that the device is always in a technically perfect condition, and therefore the following applies:

- Owner must ensure that the maintenance intervals described in these operating instructions are complied with.
- Owner must have all safety devices inspected regularly for function and completeness.

## 2.3 Personnel requirements

### 2.3.1 Qualifications

**WARNING!****Danger of injury if insufficiently qualified!**

Improper operation can lead to serious personal injuries or property damage.

Therefore:

- Have all activities performed only by qualified personnel.

The following qualifications are specified for different areas of activity listed in the Manual.

- **An instructed person**  
has been instructed by the customer in an orientation session on the assigned tasks and possible dangers in case of improper behavior.
- **Qualified personnel**  
based on their professional training, know-how and experience as well as knowledge of the applicable standards and regulations is able to perform assigned work activities and to detect and avoid possible dangers on their own.
- **A professional electrician**  
based on his/her professional training, know-how and experience as well as knowledge of the applicable standards and regulations is able to perform work on electrical systems and to detect and avoid possible dangers on his/her own.  
The professional electrician has been trained for the special location where he/she works and knows the relevant standards and regulations.
- **Hydraulic specialist**  
based on his or her technical training, knowledge and experience as well as knowledge of the relevant standards and regulations, is able to carry out work on hydraulic systems and to independently recognise and avoid possible dangers.  
The hydraulic specialist is trained for the specific location at which he or she is employed and is familiar with the relevant standards.

## Safety

### 2.3.2 Unauthorized persons



**WARNING!**

**Danger for unauthorized persons!**

Unauthorized persons not meeting the requirements outlined here are not aware of the dangers in the work area.

Therefore:

- Keep unauthorized persons away from the work area.
- If in doubt, address the persons and direct them to leave the work area.
- Interrupt work activities as long as unauthorized persons are present in the work area.



## 2.4 Personal protective equipment

When working, it may be necessary to wear personal protective equipment in order to minimise dangers to health.

- During work, always wear the protective equipment necessary for the particular work.
- Follow the information placed in the working area with regard personal safety equipment.

### Personal protective equipment for special tasks

When performing special tasks it is necessary to wear personal protective equipment. This personal protective equipment will be separately specified in the chapters of this Manual. This special protective equipment is explained below.



#### Protective clothing

means close-fitting working clothes with long arms and long trousers. It serves primarily as protection against hot surfaces.



#### Protective gloves

to protect the hands against abrasions, cuts or deeper wounds as well as against contact with hot surfaces.



#### Safety goggles

to protect the eyes against parts flying around or squirts of fluids.



#### Safety boots

to protect against heavy parts falling down or slipping on slippery ground.

## Safety

### 2.5 Specific dangers

The following section lists the residual risks that have been determined by the risk assessment.

- Heed the safety instructions listed here, and the warnings in subsequent chapters of this Manual, to reduce health hazards and to avoid dangerous situations.

#### Electric current



#### **DANGER!**

#### **Danger of death by electric current!**

Live parts are dangerous. Contact with high voltages causes injury or death. Damaged insulation or components can cause injury or death.

Therefore:

- In case of damage of the insulation of the power supply, switch off immediately and arrange repair.
- Work on the electrical system must only be carried out by certified electricians.
- For all work on the electrical system, for maintenance, cleaning or repair work, disconnect from the mains or disconnect all phases of the external power supply and secure them against being switched on again. Check unit is isolated from power supply.
- Do not by-pass or disable fuses. Comply with the correct ampere when changing fuses.
- Keep away humidity from live parts. This could cause a short circuit.

#### Hot materials



#### **WARNING!**

#### **Danger of burns due to hot working materials!**

During operation, working materials can reach high temperatures and pressures and can cause burns on contact.

Therefore:

- Only allow work on the hydraulics to be carried out by qualified personnel.
- Before beginning work on the hydraulics, check whether working materials are hot and under pressure. If necessary, cool the unit down, depressurise and switch off. Check that the unit is free of pressure.

**Hot surfaces****CAUTION!****Danger of burning on hot surfaces!**

Contact with hot components can cause severe burns.

Therefore:

- Always wear protective clothes and protective gloves when working on hot components.
- Before starting work make sure that all components have cooled down to ambient temperature.

**Danger of crushing****WARNING!****Danger of crushing due to rolling away or tipping**

With an uneven floor or when the castors are not locked, there is a danger that the unit tips over or rolls away causing crushing.

Therefore:

- Only install the unit on an even floor.
- Ensure that the castors are locked.

## Safety

### 2.6 Safety devices



**WARNING!**  
**Malfunctioning safety devices may pose a fatal risk!**

Safety devices must be intact in order to guarantee safety.

Therefore:

- Never disable safety devices.
- Take care to ensure that safety devices such as main switch are always accessible.

#### Main switch

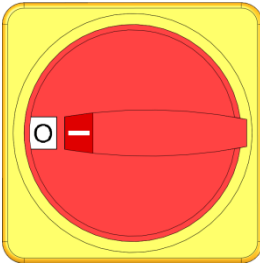

Fig. 1: Main switch

The power supply to consumers is cut and an emergency stop is triggered by turning the main switch to the "0" position.



**WARNING!**  
**Danger of fatal injury from uncontrolled restarting!**

Premature uncontrolled restarting can lead to severe personal injury or to death!

Therefore:

- Before restarting, make sure that the cause for the emergency stop is eliminated and all safety devices are installed and operational.



**WARNING!**  
**Danger of fatal injury from live conductors!**

After switching off the unit via the main switch, there are still live conductors in the unit!

Therefore:

- For all work on the electrical system, for maintenance, cleaning or repair work, disconnect from the mains or disconnect all phases of the external power supply and secure them against being switched on again
- Check unit is isolated from power supply

## 2.7 Stickers and decals

The following symbols and information decals can be found in the danger zone. They refer to the immediate vicinity around their location.

**WARNING!****Danger of injury because of illegible symbols!**

Over the course of time stickers and decals may become dirty or illegible for any other reason.

Therefore:

- Keep any safety, warning and operation related decals in legible condition at all times.
- Replace damaged decals or stickers immediately.

**Hot surfaces**

Hot surfaces, like hot machine parts, tanks or materials, but also hot fluids, are not always detectable. Do not touch without protective gloves.

## Safety

### 2.8 CE Declaration of Conformity for Machinery

(CE-Directive 2006/42/EG, Annex II 1. A.)

<b>Product</b>	Temperature Control Unit HB-Therm Thermo-5
<b>Unit types</b>	HB-100Z3      HB-160Z3 HB-140Z3      HB-180Z3
<b>Manufacturer Address</b>	HB-Therm AG Piccardstrasse 6 9015 St. Gallen SWITZERLAND www.hb-therm.com
<b>CE guidelines</b> Note on the pressure equipment line 2014/68 / EU	2014/30/EU; 2011/65/EU The above products are in accordance with Article 4 (3). This means that interpretation and production are consistent with good engineering practice in the Member State.
<b>Responsible for documentation</b>	Martin Braun HB-Therm AG 9015 St. Gallen SWITZERLAND
<b>Standards</b>	EN IEC 60730-2-9:2019 + A1:2019 + A2:2020; EN IEC 61000-6-2:2019; EN IEC 61000-6-4:2019; EN IEC 63000:2018; EN ISO 12100:2010; EN ISO 13732-1:2008; EN 60204-1:2018; EN 12828:2012 + A1:2014; EN 12953-6:2011  We declare of our own responsibility that the above mentioned products, to which this declaration refers, comply with the appropriate regulations of the CE-Machinery Directive. (CE-Directive 2006/42/EG), including its appendices and the corresponding legal remission for implementation of the directive in national law. Furthermore, the above mentioned CE-Directives and standards (or parts/clauses thereof) are applied.

St. Gallen, 2023-08-17



Reto Zürcher  
CEO



Stefan Gajic  
Compliance & Digitalisation

## 2.9 UK Declaration of Conformity for Machinery

(Supply of Machinery (Safety) Regulation 2008, Statutory Instrument 2008 No. 1597)

<b>Product</b>	Temperature Control Unit HB-Therm Thermo-5
<b>Unit types</b>	HB-100Z3      HB-160Z3 HB-140Z3      HB-180Z3
<b>Manufacturer Address</b>	HB-Therm AG Piccardstrasse 6 9015 St. Gallen SWITZERLAND www.hb-therm.com
<b>UK guidelines</b>	The Electromagnetic Compatibility Regulations 2016 Statutory Instruments 2016 No. 1091  The Restriction of the Use of Certain Hazardous Substances in Electrical and Electronic Equipment Regulations 2012 Statutory Instruments 2012 No. 3032
Note on The Pressure Equipment (Safety) Regulations 2016 Statutory Instruments 2016 No. 1105	The above products are in accordance with regulation 8. This means that interpretation and production are consistent with good engineering practice.
<b>Responsible for documentation</b>	Martin Braun HB-Therm AG 9015 St. Gallen SWITZERLAND
<b>Standards</b>	EN IEC 60730-2-9:2019 + A1:2019 + A2:2020; EN IEC 61000-6-2:2019; EN IEC 61000-6-4:2019; EN IEC 63000:2018; EN ISO 12100:2010; EN ISO 13732-1:2008; EN 60204-1:2018; EN 12828:2012 + A1:2014; EN 12953-6:2011

We declare of our own responsibility that the above mentioned products, to which this declaration refers, comply with the appropriate regulations of the Supply of Machinery (Safety) Regulations 2008, including its appendices. Furthermore, the above mentioned Statutory Instruments and standards (or parts/clauses thereof) are applied.

St. Gallen, 2023-08-17



Reto Zürcher  
CEO



Stefan Gajic  
Compliance & Digitalisation

## Technical data

### 3 Technical data

#### 3.1 General Information

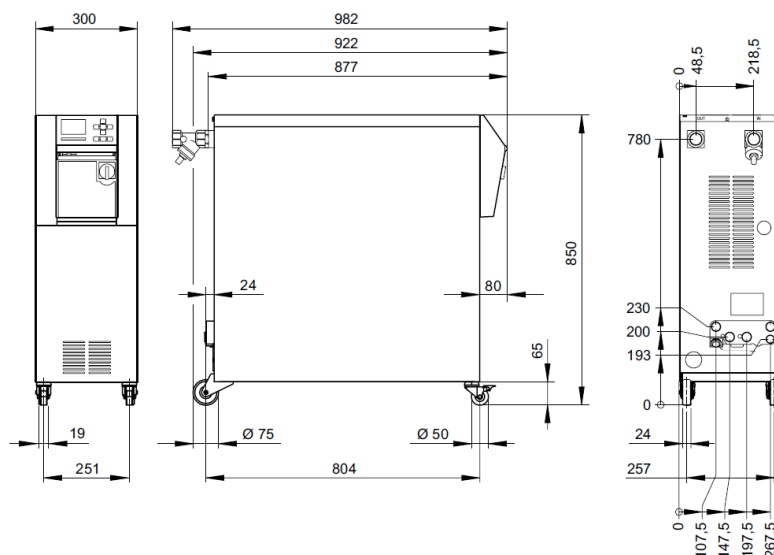

Fig. 2: Dimensions

#### Max. weight

	Value	Unit
HB-100Z3	147	kg
HB-140Z3	151	kg
HB-160Z3	151	kg
HB-180Z3	150	kg

#### Temperature measurement

	Value	Unit
Measuring range	0–400	°C
Dissolution	0,1	°C
Control accuracy	±0,1	K
Tolerance	±0,8	K

#### Flow measurement

	Value	Unit
Measuring range	2–200	L/min
Dissolution	0,1	L/min
Tolerance	±(5 % of the measured value + 0,5 L/min)	

#### Pressure measurement

	Value	Unit
Measuring range	0–20	bar
Dissolution	0,1	bar
Tolerance	±5 % of the final value	



**Technical data**

**3.2 Emissions**

	Value	Unit
Continuous sound pressure level	<70	dB(A)
Surface temperature (rear of unit)	>55	°C

**3.3 Operating conditions**

**Environment**

The unit may only be operated indoors.

	Value	Unit	
Temperature range	5–40	°C	
Relative humidity *	35–85	% RH	
Minimum free space (→ Fig.)	A **	10	mm
	B	50	mm
	C	150	mm
	D	50	mm
	E	70	mm

\* non-condensing

\*\* at ambient temperatures up to max. 35 °C, the units can be placed next to each other without any distance.

**!** **ATTENTION!**  
**Reduced service life due to insufficient cooling!**  
 If the unit is not cooled sufficiently, the service life of the components is reduced.  
 Therefore:  
 – Do not cover air vents

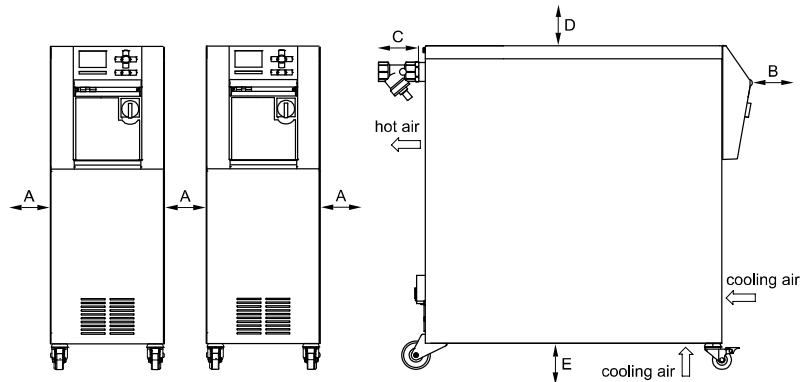

Fig. 3: Free space around the unit

## Technical data

### 3.4 Connection values

#### Electrical connection

Mains cable to unit, cross section	CE	H07RN-F/H07BQ-F
	$U_N = 400/460 \text{ V}$	4x2,5 mm <sup>2</sup> (8 kW) 4x6,0 mm <sup>2</sup> (16 kW) 4x16,0 mm <sup>2</sup> (32 kW)
	$U_N = 210 \text{ V}$	4x6,0 mm <sup>2</sup> (8 kW) 4x16,0 mm <sup>2</sup> (16 kW) 4x50,0 mm <sup>2</sup> (32 kW)
Power grid	TN (net with protective conductor)	
Mains voltage $U_N$	see nameplate on unit or on page 2	
Rated short-circuit current	$I_{max}$ to 63 A / 125 A = 6 kA / 10 kA	
Overvoltage category	II	
Degree of contamination	2	

Maximum fusing:

	380–415 V	200–220 V	440–480 V
Heating 8 kW	3x20 A	3x32/50 A	3x20 A
Heating 16 kW	3x32 A	3x63 A	3x32 A
Heating 32 kW	3x63 A	3x125 A	3x63 A



#### NOTICE!

#### **On units without frequency converter**

To protect against electric shock, the use of a residual current circuit-breaker (RCD) Type A is recommended.

Motor current setting FS 4:

Mains voltage		Pump						
		200–220 V, 50–60 Hz	200–220 V, 50 Hz	200–220 V, 50/60 Hz	380–420 V, 50–60 Hz	380–415 V, 50 Hz	380–415 V, 50/60 Hz	440–480 V, 60 Hz
FA/ FU	A	5,6	-	-	3,4	-	-	3,4
GA/ GU	A	11,8	-	-	6,8	-	-	6,8
LA	A	16,0	-	-	9,3	-	-	9,3
LU	A	16,0	-	-	9,6	-	-	9,6
4G/ 4M	A	-	4,8	4,5	-	2,8	2,6	2,6
6G/ 6M	A	-	12,1 (11,1)	15,8 (12,6)	-	6,9 (6,4)	9,2 (7,3)	5,9 (5,6)
8G/ 8M	A	-	16,0 (15,2)	17,7 (15,4)	-	9,3 (8,8)	10,0 (8,9)	8,6 (8,1)

() = Setting value for energy efficiency class IE2 motor

## Technical data

### Connection main and return line

	Value	Unit
Thread	G1 ¼	
Resistance HB-100Z3	20, 120	bar, °C
Resistance HB-140Z3	20, 160	bar, °C
Resistance HB-160Z3	20, 180	bar, °C
Resistance HB-180Z3	25, 200	bar, °C

G... Connector inside thread in inches

### Connection cooling water, separate system water

	Value	Unit
Pressure	2–5	bar
Thread cooling water	G¾	
Thread separate system water	G½	
Resistance	10, 100	bar, °C

G... Connector inside thread in inches

### Compressed air connection

	Value	Unit
Pressure	2–8	bar
Thread	G½	
Resistance	10, 100	bar, °C

G... Connector inside thread in inches

### Drain connection

	Value	Unit
Thread	G ½	

G... Connector inside thread in inches

## Technical data

### 3.5 Operating fluids

#### Heat transfer medium

Normally, if the non-treated water used in the temperature control circuit observe following guideline values, it can be used without special treatment.



#### NOTICE!

*We recommend, in order to protect the system, to observe these values and to control them from time to time.*

#### Guideline values

Hydrological data	Temperature range	Guideline value	Unit
pH-value	-	7.5–9	
Conductivity	up to 110 °C	<150	mS/m
	110–180 °C	<50	
	over 180 °C	<3	
Total hardness	up to 140 °C	<2.7	mol/m <sup>3</sup>
		<15	°dH
	over 140 °C	<0.02	mol/m <sup>3</sup>
		<0.11	°dH
Carbonate hardness	up to 140 °C	<2.7	mol/m <sup>3</sup>
		<15	°dH
	over 140 °C	<0.02	mol/m <sup>3</sup>
		<0.11	°dH
Chlorid ions Cl -	up to 110 °C	<50	mg/L
	110–180 °C	<30	
	over 180 °C	<5	
Sulphate SO <sub>4</sub> 2-	-	<150	mg/L
Ammonium NH <sub>4</sub> +	-	<1	mg/L
Iron Fe	-	<0.2	mg/L
Manganese Mn	-	<0.1	mg/L
Particle size	-	<200	µm



#### NOTICE!

*For further information, you can go to [www.hb-therm.ch](http://www.hb-therm.ch) to download "Checklist for water treatment for temperature control units" (DF8003-X, X=language).*

#### Water treatment

If the guideline values cannot be observed, a professional water treatment is necessary (→ page 42).

### 3.6 Nameplate

The nameplate is located on the rear panel of the unit, on the inside of the service flap and on page 2 of these operating instructions.

The following information can be taken from the nameplate:

- Manufacturer
- Type designation
- Unit number
- Year of manufacture
- Performance data
- Connection data
- Type of protection
- Additional equipment

## Structure and function

### 4 Structure and function

#### 4.1 Overview

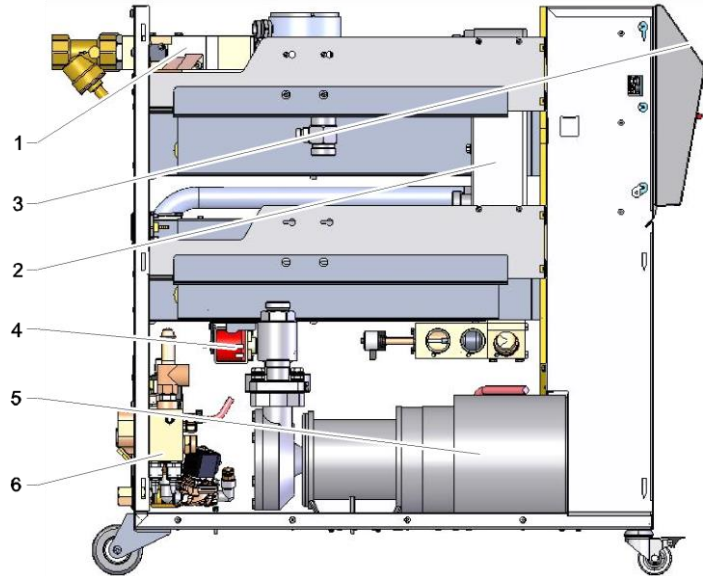

Fig. 4: Overview

- 1 Heat transfer module
- 2 Cooler
- 3 Operation and display
- 4 Filling pump
- 5 Pump
- 6 Cooling water module

#### 4.2 Brief description

The temperature control unit uses a heater and a cooler to bring the heat transfer medium water to the desired temperature and keeps this constant. The temperature controlled heat transfer medium is passed from the temperature control unit to the consumers and back again by means of a pump.

Together with the pipework and the consumers, the temperature control unit forms a heat transfer system.

### 4.3 Functional principle

The temperature control unit is a self-venting system. It comprises a pump, a heating element and a cooling element and serves as a pressure vessel for the heat transfer medium.

A temperature sensor measures the temperature of the heat transfer medium in the temperature control unit and forwards it in the form of an electrical signal to the controller input. Optionally, an external temperature sensor mounted on the consumer can be connected to the unit.

The heating and cooling elements of the unit are switched on accordingly by the temperature controller until the heat transfer medium has reached the required temperature. This temperature is kept constant. The temperature controlled heat transfer medium is fed to the consumers by means of a pump.

The heater comprises one or more heated elements.

With the indirect cooling, the cooling process takes place via a heat exchanger that has cold water flowing through it. The cooling water is supplied via the cooling water connection.

### 4.4 Heat transfer medium

Water is used as the heat transfer medium. It is automatically fed to the temperature control unit via the cooling or system water inlet.

The heat transfer medium water is located in a closed circuit without oxygen contact in order to prevent oxidation to a large extent.



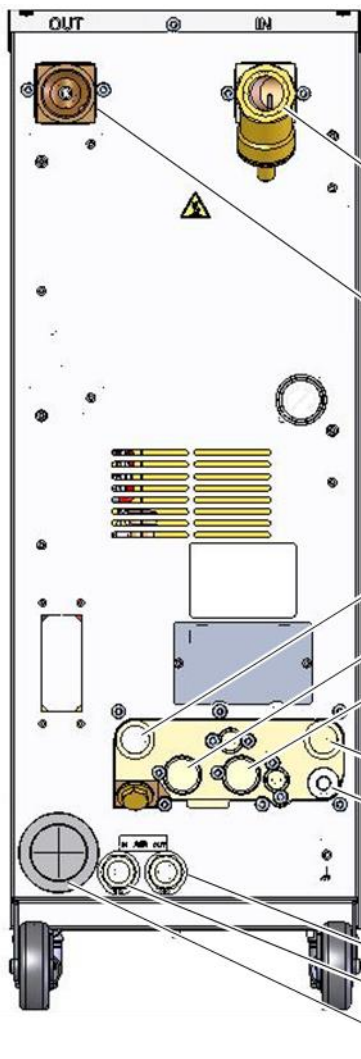

Water above 100 °C is under increased pressure (e.g. 4 bar for an operating temperature of 140 °C), i.e. the boiling point of the water is raised correspondingly by the static pressure prevailing in the circuit.

## Structure and function

### 4.5 Connections



The connections and important components on the rear of the unit are marked as follows:

- |   |   |  |
|---|---|--|
| A | <b>OUT</b>  | Main line  |
| B | <b>IN</b>   | Return line  |
| C |  | Cooling water inlet                                |
| D |  | Cooling water outlet                               |
| G |  | Emptying   |
|   |  | Pressure indicator                                 |
|   |  | Cooling water filter                               |
| E | <b>S1</b>   | System water inlet *                               |
| F | <b>S2</b>   | System water outlet *                              |
| J | <b>AIR IN</b>   | Compressed air inlet<br>(additional equipment ZG)  |
| K | <b>AIR OUT</b>  | Compressed air outlet<br>(additional equipment ZG) |
| N |   | Mains connection cable                             |

\* The connections for system water inlet and outlet can only be used when switched to separate connections for system water (→ page 43).

\*\* Only use the compressed air outlet connection when the [Mould evac. with compr. air](#) parameter is set to "Tank" (→ page 78).

Fig. 5: Connections



## Structure and function

### 4.6 Additional equipment

The following additional equipment can be installed in addition to the basic equipment for the unit (→ nameplate):

	Additional equipment	Description
ZG	Mould evacuation with compressed air	Alternative to the standard integrated Mould evacuation by pump reversal
ZB	Connection for alarm and external control	Alarm using potential-free contact (rating max. 250 VAC, 4 A) Unit ON/OFF, ramp program ON/OFF and switching nominal value 1 or 2 using potential-free contact 1 socket Harting Han 7D (male), connecting cable with plug included
ZE	Connection for external sensor	Thermocouple type J, K, T or Pt 100 in 3-wire system, with selectable production detector 1 socket Audio 5 pin (female), connector 90° (male) included
ZD	Interface DIGITAL	Serial data interface 20 mA, RS-232 or RS-422/485 Various protocols selectable: Arburg, Billion, Bühler, Dr. Boy, Engel, Ferromatik Milacron, Haitian, KraussMaffei, MODBUS (RTU-Mode), Negri Bossi, SPI (Fanuc, etc.), Stork, Sumitomo Demag, Wittmann Battenfeld, Zhafir 2 sockets Sub-D 25 pin (female)
ZC	Interface CAN	Series data interface CAN-bus (Sumitomo Demag) and CANopen (EUROMAP 66; Netstal, etc.) To remotely control singular units 2 sockets Sub-D 9 pin (1 male and 1 female)
ZO	Interface OPC UA	Ethernet interface (EUROMAP 82.1) 1 socket RJ-45 (female)
ZP	Interface PROFIBUS-DP	Serial data interface PROFIBUS-DP 1 socket sub-D 9 pin (female; not possible with ZC)
ZU	Pump status monitor	Additional pressure sensor in main line
ZK	Keyboard-protection	Transparent flap over display and controls
ZR	Clean room package	Clean room capable version “At Rest” < ISO class 6 (class 1000) “In Operation” ISO class 7 (class 10 000) Fibre-free insulation
X	Special Design	Special design without additional description
XA	Special Design with appendix	Special design with additional description in Appendix A

## Structure and function

### 4.7 Operation modes

#### 4.7.1 Main operating modes



**NOTE!**

*After switching the unit on, the last main operating mode selected is again active, if necessary after expiry of a delay time*

#### Normal operation

During normal operation, the temperature controlled heat transfer medium is pressed through the consumers by means of a pump.

#### 4.7.2 Auxiliary modes

##### Mould evacuation

In the auxiliary mode mould evacuation, the heat transfer medium is cooled until the main line, return line and external\* temperatures have reached the defined [Mould evacuation limit temp.](#). Afterwards, the consumers and the supply hoses are sucked empty and depressurised. The evacuation volume is led to the cooling water or system water outlet or to the compressed air outlet.

##### Cooling

In the auxiliary mode cooling, the heat transfer medium is cooled until the main line, return line and external\* temperatures have reached the defined [Cooling temperature](#). Afterwards, the unit is depressurised and switched off.

\* if external sensor connected

### 4.8 Work and danger zones

#### Working areas

- The primary working area is located at the front of the unit on the keyboard.
- The secondary working area is located at the rear of the unit.

#### Danger areas

- Connection of the unit to the consumers is made at the rear of the unit. These areas are not protected by the unit housing. There is a risk of burns on accessible hot surfaces. If a hose bursts, hot steam or hot water can escape and cause burns.

## Transport, packing and storage

### 5 Transport, packing and storage

#### 5.1 Safety notes for transport

##### Improper transport



##### **ATTENTION!**

##### **Damage due to improper transport!**

Improper transport can result in considerable material damage.

Therefore:

- Unit must be completely emptied (cooling and system circuit)
- Only use original or equivalent packaging.
- On delivery as well as during internal transport, proceed carefully when unloading the packages and observe the notices on the packaging.
- Only use the designated suspension points.
- Only remove the packaging shortly before assembly.

#### 5.2 Transport

##### Transport by forklift truck

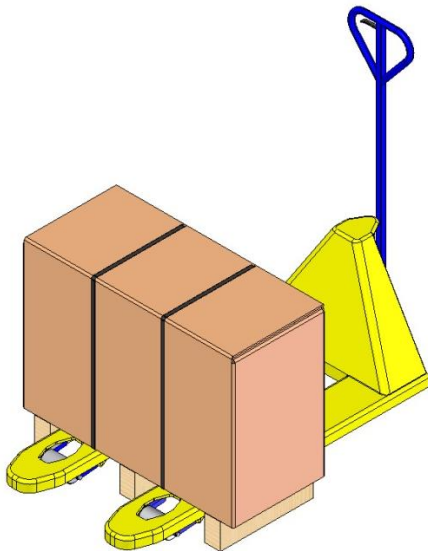

Fig. 6: Attachment points Palette

Packing units mounted on pallets can be transported by forklift truck under the following condition:

- The forklift truck must be designed for the weight of the unit.
- The driver must be authorised to drive the forklift truck.

##### **Attachment:**

1. Insert the forks of the forklift truck between or under the pallet stringers.
2. Insert the forks deep enough so they protrude on the other side of the pallet.
3. Make sure that the pallet cannot tip over, if the centre of gravity is offset.
4. Raise the packing unit and begin with the transport.

## Transport, packing and storage

### Transport with a crane

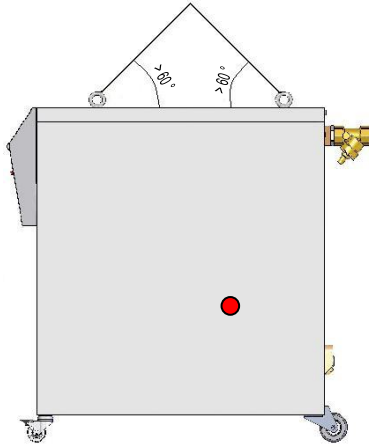

Fig. 7: Suspension points

The unit can be equipped with lifting brackets (special design). Transport with a crane can be carried out under the following conditions:

- Crane and lifting gear must be designed for the weight of the unit.
- The operator must be authorised to operate the crane.

#### Attachment:

1. Attach the ropes and straps according to Fig. 7.
2. Ensure that the unit hangs straight, pay attention to off-centre centre of gravity (→ ● Fig. 7).
3. Raise the unit and begin with the transport.

## Transport, packing and storage

### 5.3 Transport inspection

Check the delivery immediately on receipt for completeness and transport damage.

If externally detectable transport damage is found, proceed as follows:

- Do not accept the delivery, or only with reservation.
- Record the extent of transport damage in the transport documents or on the delivery note of the forwarding agent.
- Start complaints procedure.



**NOTE!**

*Claim any damage as soon as it is detected. Compensation claims can only be submitted within the applicable complaints periods.*

### 5.4 Packing

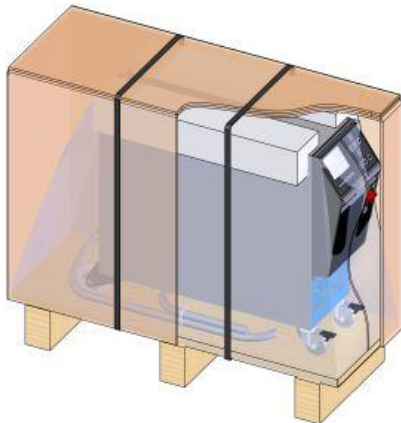

Fig. 8: Packaging

The unit is packed corresponding to the expected transport conditions on a wooden pallet, secured with a polypropylene strap and wrapped in stretch film.

Only environmentally compatible materials have been used for the packaging.

The packaging should protect the individual components from transport damage, corrosion and other damage. Therefore, do not destroy the packaging.

## Transport, packing and storage

### Handling packing materials

If there is no returns agreement for the packing, separate materials according to type and size and direct to further use or recycling.



#### **ATTENTION!**

#### **Environmental damage caused by incorrect waste disposal!**

Packing materials are valuable raw materials and can continue to be used in many cases or sensibly reconditioned and recycled.

Therefore:

- Dispose of packing materials environmentally.
- Follow the locally valid waste disposal regulations. If necessary employ a special waste disposal company to dispose of packing material.

### Recycling codes for packaging materials

Recycling codes are markings on packaging materials. They provide information about the type of material used and facilitate the disposal and recycling process.

These codes consist of a specific material number framed by an arrow-triangle symbol. Below the symbol is the abbreviation for the respective material.



no recycling code

#### **Transport pallet**

→ Wood

#### **Folding carton**

→ Cardboard

#### **Strapping band**

→ Polypropylene

#### **Foam pads, cable ties and quick release bags**

→ Polyethylene low density

#### **Stretch film**

→ Polyethylene linear low density

## Transport, packing and storage

### 5.5 Symbols on the packing



#### Protect against wetness

Protect packages against wetness and keep dry.



#### Fragile

Identifies packages with fragile or sensitive content.

Handle package with care, do not drop and do not subject to shock loads.

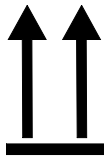

#### Top

The arrows in this sign symbolize the top side of the package. They must always point up, as otherwise the content may get damaged.



#### Do not stack

Marks packages that cannot be stacked or onto which nothing should be stacked.

Do not stack anything on the marked package.

### 5.6 Storage

#### Storing the packages

Store the packages under the following conditions:

- Temperature control unit completely emptied.
- Do not store out of doors.
- Store dry and dust-free.
- Do not expose to aggressive media.
- Protect from sunlight.
- Avoid mechanical vibrations.
- Storage temperature 15–35 °C.
- Relative humidity max. 60 %.

## Installation and initial commissioning

# 6 Installation and initial commissioning

## 6.1 Safety

### Personnel

- The installation and commissioning must only be carried out by qualified personnel.
- Work on the electrical system must only be carried out by certified electricians.
- Work on the hydraulic system must only be carried out by qualified hydraulics technicians.

### Special dangers

The following dangers exist:

- Danger of fatal injury by electric current.
- Risk of burns due to hot materials.
- Risk of burns due to hot surfaces.
- Danger of crushing due to rolling away or tipping.

### Improper installation and initial commissioning



#### **WARNING!**

#### **Risk of injury due to improper installation and initial commissioning!**

Improper installation and initial commissioning can lead to severe personal injury or material damage.

Therefore:

- Before starting work, ensure that there is sufficient space for assembly.
- Open components with sharp edges should be handled carefully.



## Installation and initial commissioning

### 6.2 Requirements for the installation location

**WARNING!**

**Improper installation can cause risk of injury and fire!**

Improper installation can lead to severe personal injury or material damage.

Therefore:

- Observe and comply with the requirements at the installation site

Install the temperature control unit under the following conditions:

- ensure adequate ventilation and a water-protected unit location
- on a horizontal, stable and low-vibration surface
- secured against rolling away and tipping
- ensure access to the main switch at all times
- all connection cables of the unit must not touch hydraulic lines or parts whose surface temperatures are above 50 °C
- protect the unit with a suitable back-up fuse and, if necessary, a residual current circuit breaker (max. back-up fuse and recommended residual current circuit breaker → page 26)

## Installation and initial commissioning

### 6.3 Installation work

#### 6.3.1 Lock castors

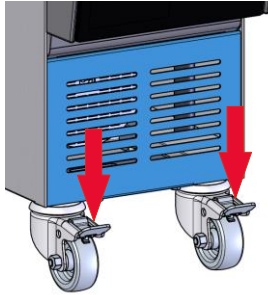

Fig. 9: Lock castors

The castors must be locked in order to secure the unit from rolling away unintentionally.

1. Place the unit in the appropriate location.
2. Press the two brake arms on the castors downwards.

#### 6.3.2 Water treatment

If the guideline values (→ page 28) for water quality during operation cannot be observed, a professional water treatment is necessary.



#### NOTICE!

*We recommend having the water treatment undertaken by a specialist firm.*

Carry out the water treatment under the following conditions:

- Water treatment agents must be capable of being used up to the maximum working temperature of the temperature control unit.
- Do not use any aggressive water treatment agents that could destroy the materials of the system. Depending on the model, the following materials are used in the system:
  - Copper
  - Brass
  - Bronze
  - Nickel
  - Chrome steel
  - MQ (silicon)
  - Titan
  - NBR (Nitrile rubber)
  - FPM (Viton®)
  - PTFE (Teflon)
  - FFKM (Perfluorinated rubber)
  - PEEK (Polyether ether ketone)
  - Ceramic (Al<sub>2</sub>O<sub>3</sub>)

Viton® is a registered trademark of Dupont Dow Elastomers



#### NOTICE!

*For further information, you can go to [www.hb-therm.ch](http://www.hb-therm.ch) to download "Checklist for water treatment for temperature control units" (DF8003-X, X=language).*

## Installation and initial commissioning

### 6.3.3 Set the separate connection for system water

The common connection for cooling and system water can be changed over to separate connections.

#### Necessary equipment

- Torx screwdriver
- Slotted screwdriver

#### Separate connection cooling and system water inlet

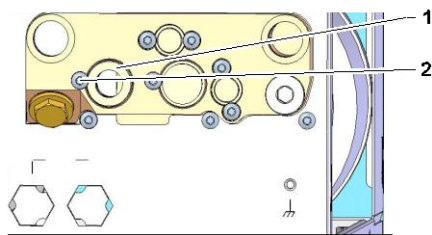

Fig. 10: Separate connection cooling and system water inlet

Proceed as follows in order to change to separate connection for cooling and system water inlet:

1. Remove the Torx screws (2) with the Torx screwdriver.
2. Insert the flat-blade screwdriver into the groove of the trunnion (1) and press it out.
3. Refit the trunnion (1) the other way round with the screw connection visible outwards.
4. Retighten the Torx screws (2) with the Torx screwdriver (pay attention to the notch in the trunnion).

#### Separate connection cooling and system water outlet

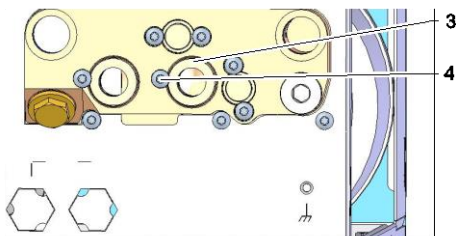

Fig. 11: Separate connection cooling and system water outlet

Proceed as follows in order to change to separate connection for cooling and system water outlet:

1. Remove the Torx screws (4) with the Torx screwdriver.
2. Insert the flat-blade screwdriver into the groove of the trunnion (3) and press it out.
3. Refit the trunnion (3) the other way round with the screw connection visible outwards.
4. Retighten the Torx screws (4) with the Torx screwdriver (pay attention to the notch in the trunnion).

## Installation and initial commissioning

### 6.3.4 Setting up system connections



**WARNING!**  
**Danger from hydraulic energy!**

When using unsuitable pressure lines and connectors, the danger exists that liquids under high pressure can escape and cause severe or fatal injuries.

Therefore:

- Use only temperature-resistant pressure lines.



**NOTICE!**

*Specific to the product, system connections are screwed or plugged in. If the recommended size of hose cannot be connected to the consumer, a reduction in bore at the consumer and not at the unit must be achieved to keep the pressure drop to a minimum.*



**WARNING!**

Bolted assemblies, especially combinations of stainless steel / stainless steel or steel / stainless steel tend to adhere strongly or can seize up after a longer period of operation at high temperatures. This results in difficulties in dismantling.

Therefore:

- Use a suitable lubricant.

## Installation and initial commissioning

### Connect cooling water inlet and outlet



#### NOTE!

*In order to optimally utilize the cooling capacity of the temperature control unit, keep the cooling water outlet as short and free of back-pressure as possible.*

1. Connect cooling water inlet and outlet to cooling water system.

### Connect main and return lines

2. Connect main and return lines to the consumers

### Connect system water inlet and outlet

3. Optionally connect system water inlet and outlet to system water system.

### Connecting compressed air in-/outlet (Additional equipment ZG)

4. Connect compressed air in-/outlet to the compressed air supply.

### Make electrical connections

5. Electrical connections should be made by a certified electrician under the following conditions:
  - Only make the electrical connections after the hydraulic connections have been made.
  - Ensure that mains voltage and frequency corresponding to the specification on the nameplate and in the technical data are observed.
  - Prefuse the temperature control unit in accordance with the electrical specifications (→ Connection values).

### Secure hose connections



#### WARNING!

#### Danger of burns due to hot hose connections!

During operation, the hose connections between the temperature control unit and the external consumer can become very hot. With insufficient coverage of the hose connections there is the danger of contact which can cause severe burns.

Therefore:

- Secure all hose connections adequately against the possibility of direct contact.

## Installation and initial commissioning

### 6.3.5 Connect data interfaces

#### HB interface

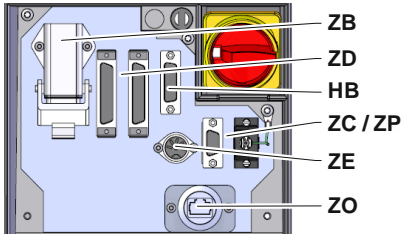

Fig. 12: Interfaces individual unit

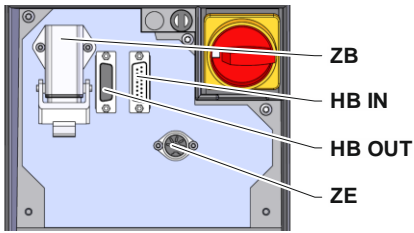

Fig. 13: Interfaces modular unit

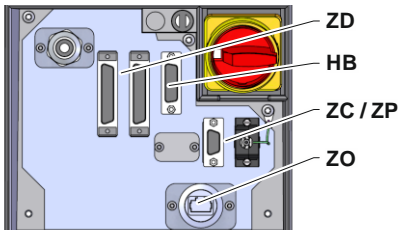

Fig. 14: Interfaces Panel-5



Fig. 15: Interfaces Flow-5  
Modul: Unit attached/ stand-alone

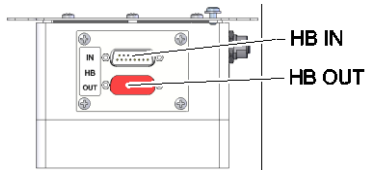

Fig. 16: Interfaces Flow-5  
Modul: Autonom.

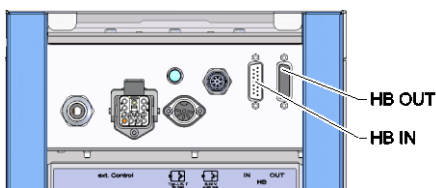
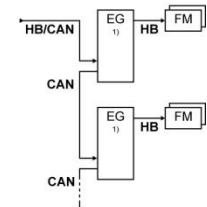
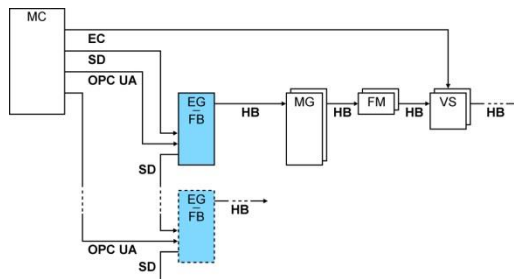

Fig. 17: Interfaces Vario-5

To operate or monitor a modular unit Thermo-5 Ext. Flow meter Flow-5 or a switching unit Vario-5, a control cable must be connected to the device:

1. Loop the control cable between the front and the service cover at Thermo-5 resp. Panel-5.
2. Plug the control cable into socket HB IN.
3. Attach the other side of the control cable to the HB-Therm Thermo-5, Flow-5 or Vario-5 through the HB IN plug.
4. Attach additional HB-Therm products through the socket HB OUT.
5. Close the service lid.

Legend	Designation	Comment
MC	Machine controller	max. 1
FB	Operating module Panel-5	max. 1
EG	Temperature thermostat Thermo-5 singular unit	max. 16 (per operation)
MG	Temperature thermostat Thermo-5 modular unit	
FM	Flow meter Flow-5	max. 32 (with 4 circuits)
VS	Switching unit Vario-5	max. 8
SD	Communication via serial data interfaces DIGITAL (ZD), CAN (ZC), PROFIBUS-DP (ZP)	Maximum number of sim. modules, operating volume and transfer of flow rate values depend on the machine controller or protocol
OPC UA	Communication OPC UA via Ethernet (ZO)	
HB <sup>2)</sup>	Communication Interface HB	Order of connection not relevant
HB/CAN	Communication Interface HB/CAN	For remote control of singular units
CAN	Communication Interface CAN (ZC)	
EC	External control (ext.) Control	Configuration depends on machine controller



1) operation switched OFF  
2) Max. length cable HB: Total 50 m

# Installation and initial commissioning

## Communication examples

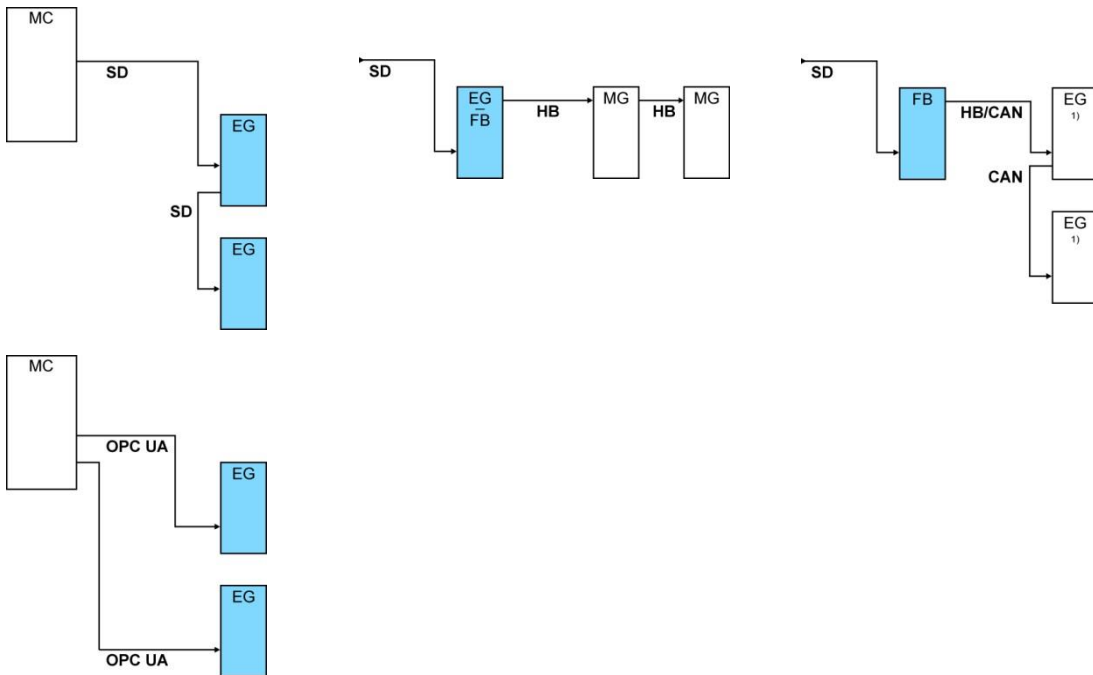

1) Operation switched OFF

## Data interface (additional equipment ZD, ZC, ZP, ZO)

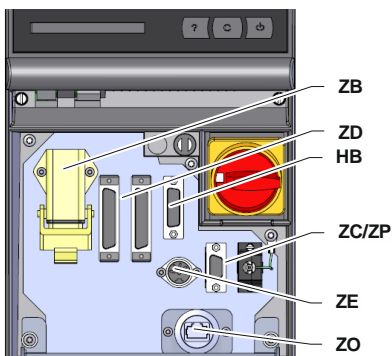

Fig. 18: Interfaces individual unit

In order to control the unit via an external controller, a control cable can be connected to the unit:

1. Pull the control cable between the front and the service cover.
2. Plug the control cable into socket ZD, ZC, ZP or ZO.
3. Close the service lid.
4. Settings for **Address** resp. of the **Protocol** (→ page 72)
5. Setting of the network configuration (only with additional equipment ZO → page 73)

## Installation and initial commissioning

### External control (additional equipment ZB)

In order to control the unit via potential-free external contacts, an external control cable can be connected to the unit:

1. Loop the external control cable between the front and the service flap.
2. Plug the external control cable into socket ZB.
3. Close the service flap
4. For the contact assignment (→ page 135)



#### NOTE!

*The pin assignment for the various control cables is given in page 134.*

### 6.3.6 Connect external sensor

#### Connect external temperature sensor (additional equipment ZE)

In order to precisely control the temperature of a consumer, an external temperature sensor can be connected to the unit:

1. Loop the cable of the external temperature sensor between the front and the service flap.
2. Plug the external temperature sensor into the socket ZE.
3. Close the service flap.
4. Setting the type of sensor (→ page 69).

Table: Sensor type designation

Type	Code	Casing	Core
J (Fe-CuNi)	IEC	black	black (+) / white (-)
	DIN	blue	red (+) / blue (-)
K (NiCr-Ni)	IEC	green	green (+) / white (-)
	DIN	green	red (+) / green (-)
T (Cu-CuNi)	IEC	brown	brown (+) / white (-)
	DIN	brown	red (+) / brown (-)



**Control**

# 7 Control

## 7.1 Keyboard

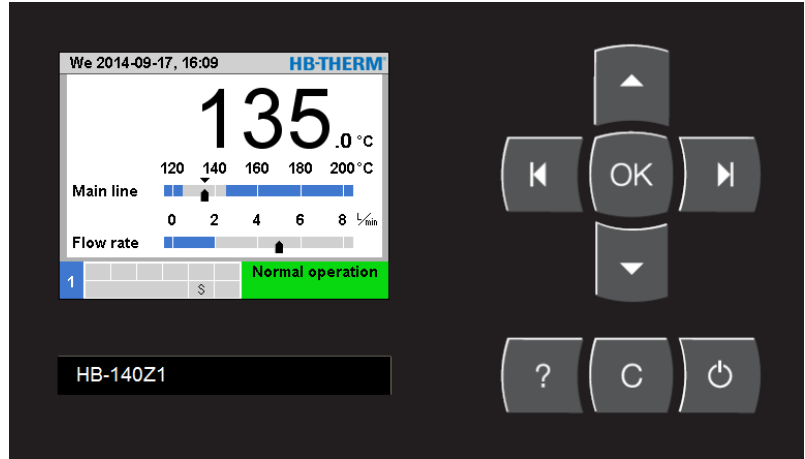

















Fig. 19: Keyboard and display

### 7.1.1 Key functions on an individual unit









Key	Key function in basic display	Key function within menu	Key function with active parameter adjustment
	In menu <b>Nominal values</b> jump to <b>Nominal value 1</b> (adjustment mode).	Navigate upwards.	Increase values.
	In menu <b>Monitoring</b> jump to <b>Monitoring</b> .	Navigate to the left.	Switch from "one tenth setting" to "whole value setting".
	Display main menu.	Display sub-menus or activate parameter adjustment.	Confirm values.
	In menu <b>Functions</b> jump to <b>Mould evacuation</b> . (Additional equipment ZG)	Navigate to the right.	Switch from "whole value setting" to "one tenth setting".
	In menu <b>Profile</b> jump to <b>Language</b> .	Navigate downwards.	Decrease values.
	Display online help.	Display online help.	Display online help.
	Acknowledge active horn or alarm.	Navigate back to previous menu.	Cancel the adjustment of values.
	Switch unit on or off.	Switch unit on or off.	Switch unit on or off.

## Control

### 7.1.2 Key functions and operation on an individual unit

Key	Key function in basic display	Key function within menu	Key function with active parameter adjustment
	In menu <b>Nominal values</b> jump to <b>Nominal value 1</b> (adjustment mode).	Navigate upwards.	Increase values.
	Navigate to lower module No.	Navigate to lower module No.	Switch from "one tenth setting" to "whole value setting".
	Display main menu.	Display sub-menus or activate parameter adjustment.	Confirm values.
	Navigate to higher module No.	Navigate to higher module No.	Switch from "whole value setting" to "one tenth setting".
	In menu <b>Profile</b> jump to <b>Language</b> .	Navigate downwards.	Decrease values.
	Display online help.	Display online help.	Display online help.
	Acknowledge active horn or alarm.	Navigate back to previous menu.	Cancel the adjustment of values.
	Switch module on or off.	Switch module on or off.	Switch module on or off.

### 7.1.3 Key functions on unit operated as module

Key	Key function in basic display	Key function within menu	Key function with active parameter adjustment
	no function	Navigate upwards.	Increase value.
	no function	no function	no function
	Display main menu.	Display sub-menus or activate parameter adjustment.	Confirm values.
	no function	no function	no function
	no function	Navigate downwards.	Decrease value.
	Display online help.	Display online help.	Display online help.
	no function	Navigate back to previous menu or leave the menu.	Cancel the adjustment of value.
	no function	no function	no function

## Control

### 7.1.4 Basic display

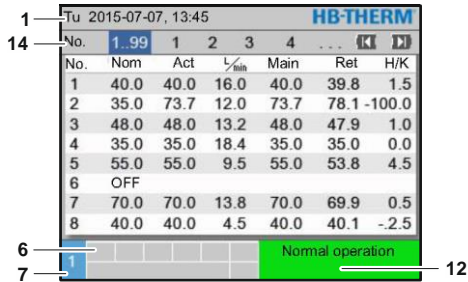

Fig. 20: Basic display table

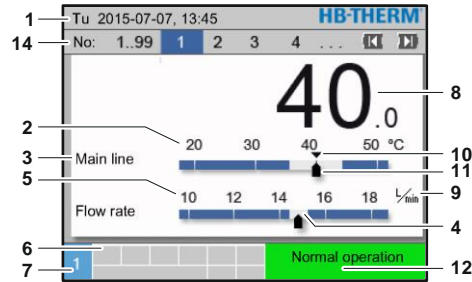

Fig. 21: Basic display graph

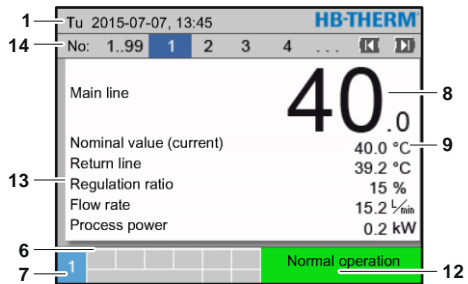

Fig. 22: Basic display text

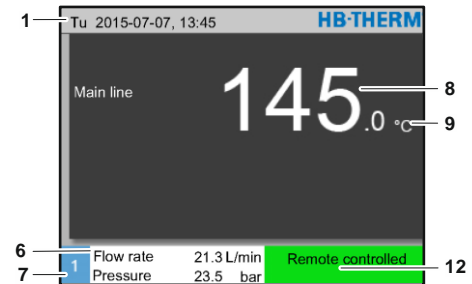

Fig. 23: Basic display Unit operated as module

Pos. no.	Designation	Display
1	Menu bar	Date and time
2	Temperature scale	Scale for current measuring position (main line, return line or external)
3	Text actual value	Upper value: Temperature main line, return line or external Lower value: Flow rate, temperature or pressure difference pump
4	Graphics bar	Display of the set monitoring limits
5	Scale	Scale for flow rate, temperature or pressure difference pump
6	Symbol field	Display active functions and details / Display actual value while display menu
7	Address field	Display unit address
8	Actual display (large)	Display of currently measured actual value (main line, return line or external)
9	Unit	Unit for flow rate, temperature or pressure
10	Nominal value	Marking of the nominal value
11	Actual value	Marking the actual value
12	Operating mode and colour-coded condition display	Display of current operating mode and pending alarms and warnings
13	User values	Display of max. 5 freely selectable actual values
14	Module bar	Shows the active modules (only when using modular units)

### Status indication individual unit

The condition display lights in a different colour depending on the operating condition. The following conditions are defined:









Display	Description
green	trouble-free
green flashing	Start-up phase, limiting values not set
yellow	Warning
red	Fault

### Status display operate unit as module or modular unit

The status display lights in a different colour depending on the operating condition. The following conditions are defined:

Display	Description
green	trouble-free
green flashing	Start-up phase, limiting values not set
green flashing fast	Modular unit selected
yellow	Warning
red	Fault
yellow/red flashing	Software update active

### Symbol display

Symbol	Description
	Simulation mode active
AT	Auto tuning active
	Remote mode active
	Ramp programme active
	Switch clock active
	Maintenance interval reached
	Recording USB
	Switch off horn
Alarm 	Acknowledge alarm

## Control

### 7.2 Operating structure

Navigate through the menu structure as follows:

- Use the **OK** key to display step-by-step the next lowest hierarchy level starting from the basic display.
- Use the **C** key to display step-by-step the next highest hierarchy level up to the basic display.
- Press the **C** key for longer than 1 second to directly display the basic display from a lower hierarchy level.
- Use the arrow keys **◀** and **▶** to switch between the individual modules.

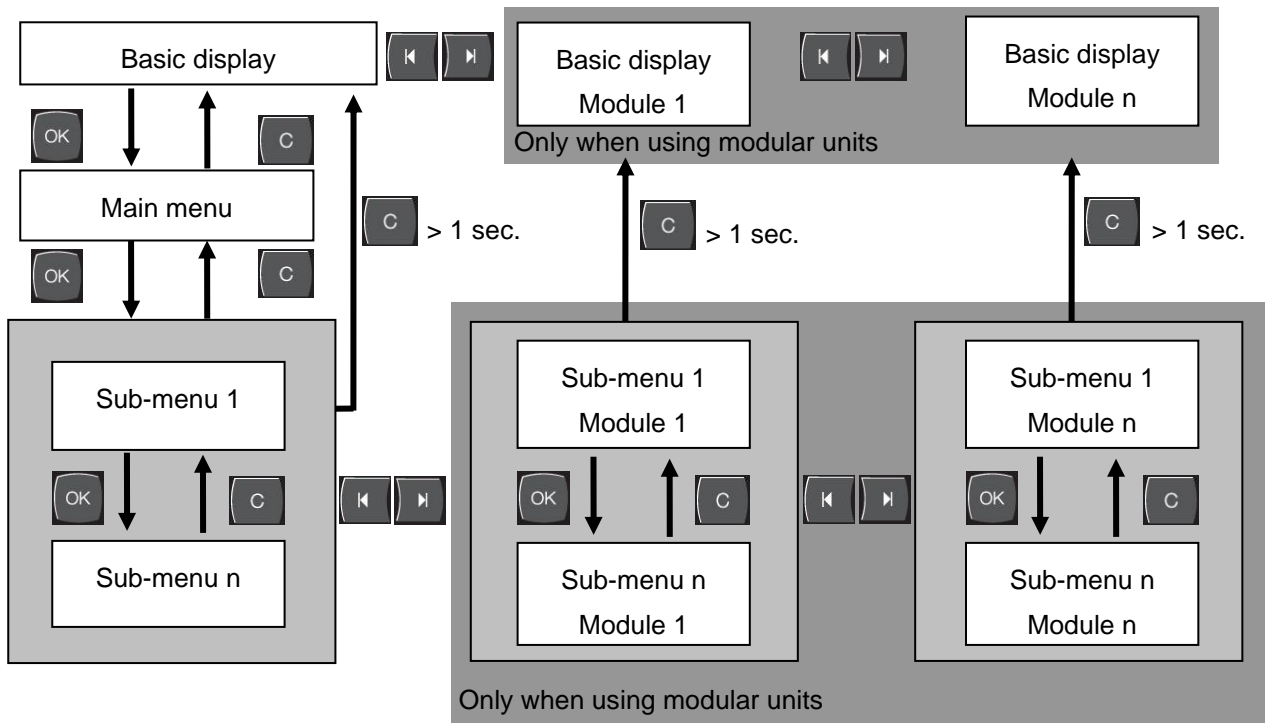

Fig. 24: Operating structure

### 7.3 Menu structure

**NOTE!**

Depending on the software version used, the menu structure and the parameter values can deviate from the following table.

Display	User profile	Operating-release	Default value	Unit	Ancillary - equipment/model	Type
<b>Nominal values</b>	S	-	-	-	-	-
Nominal value 1	S	2	40,0	°C	-	M
Nominal value 2	S	2	0,0	°C	-	M
Nominal speed	S	2	100,0	%	4S, 8R	M
Nominal flow rate	S	2	10,0	L/min	4S, 8R	M
Nominal pressure difference	S	2	3,0	bar	4S, 8R	M
Nominal temperature difference	S	2	5,0	K	4S, 8R	M
Ramp heating	E	2	5,0	K/min	-	M
Function ramp heating	E	2	inactive	-	-	M
Ramp cooling	E	2	5,0	K/min	-	M
Function ramp cooling	E	2	inactive	-	-	M
Temp. nom. value limitation	E	2	-	°C	-	M
Safety cut-off temperature	E	2	70,0	°C	-	A
Function Pressure lim. VL	E	2	inactive	-	4S, 8R	M
Pressure limitation VL	E	2	5,0	bar	4S, 8R	M
<b>Functions</b>	S	-	-	-	-	-
Cooling	S	1	OFF	-	-	M
Mould evacuation	S	1	OFF	-	-	M
External sensor	S	1	OFF	-	ZE	M
Remote	S	1	OFF	-	ZD, ZC, ZP, ZO	M
Leak stopper	S	1	OFF	-	ZL	M
2nd nominal value	S	1	OFF	-	-	M
Switch clock	S	1	OFF	-	-	M
Ramp programme	S	1	OFF	-	-	M
Ramp BREAK	S	1	OFF	-	-	M
<b>Display</b>	S	-	-	-	-	-
Screen type	S	2	Graph	-	-	A
<b>Actual values</b>	S	-	-	-	-	-
Hold screen	S	1	OFF	-	-	A
Nominal value (current)	S	-	-	°C	-	M
Main line	S	-	-	°C	-	M
Return line	S	-	-	°C	-	M

## Control

External	S	-	-	°C	-	M
Deviation actual/nominal	S	-	-	K	-	M
Difference return/main line	S	-	-	K	-	M
Regulation ratio	S	-	-	%	-	M
Flow rate	S	-	-	L/min	-	M
Process power	S	-	-	kW	-	M
act. Power saving. Pump	S	-	-	W	4S	M
Energy saving pump	S	-	-	kWh	4S	M
Possibili. Power sav. Pump	S	-	-	W	4S, 4M	M
Possibili. Energy sav. Pump	S	-	-	kWh	4S, 4M	M
Nominal temperature difference	S	-	-	K	4S, 8R	M
Nominal flow rate	S	-	-	L/min	4S, 8R	M
Nominal pressure difference	S	-	-	bar	4S, 8R	M
Nominal speed	S	-	-	%	4S, 8R	M
Pump speed	S	-	-	1/min	4S, 8R	M
System pressure nom. value	U	-	-	bar	-	M
System pressure actual value	S	-	-	bar	-	M
Main line pressure	S	-	-	bar	ZU, 4S, 8R	M
Pressure difference pump	S	-	-	bar	-	M
Pressure limitation VL	E	-	-	bar	4S, 8R	M
Operating hours	S	-	-	h	-	M
Step ramp	S	-	-	-	-	M
Remaining time ramp step	S	-	-	min	-	M
Current phase L1	U	-	-	A	-	M
Current phase L2	U	-	-	A	-	M
Current phase L3	U	-	-	A	-	M
Voltage 24 VAC	U	-	-	V	-	M
Pump condition	S	-	-	%	ZU, 4S, 8R	M
Maintenance fluid	S	-	-	%	-	M
Maintenance pump	S	-	-	%	-	M
Maintenance heating	S	-	-	%	-	M
Maintenance cooling	S	-	-	%	-	M
Difference main line/external	S	-	-	K	-	M
Return line external 1..8	S	-	-	°C	-	M
Diff. return/main line ext. 1..8	S	-	-	K	-	M
Flow rate external 1..8	S	-	-	L/min	-	M
Process power ext. 1..8	S	-	-	kW	-	M
Position cooling valve 1	U	-	-	%	-	M
Position cooling valve 2	U	-	-	%	>100 °C	M
Level tank	S	-	-	%	200/250T	M
Temperature cooler	U	-	-	°C	>100 °C	M
Temperature tank	U	-	-	°C	200/250T	M
Temperature frequency Converter	U	-	-	°C	4S, 8R	M
Temperature compensation 1	U	-	-	°C	-	M
Power pump	S	-	-	kW	4S, 8R	M



## Control

Nom. value pumps (current)	S	-	-	%	4S, 8R	M
Output pump	S	-	-	%	4S, 8R	M
Production detection	S	-	inactive	-	-	M
<b>Selection</b>	S	-	-	-	-	-
Nominal value (current)	S	3	ON	-	-	M
Main line	S	3	OFF	-	-	M
Return line	S	3	ON	-	-	M
External	S	3	OFF	-	-	M
Deviation actual/nominal	S	3	OFF	-	-	M
Difference return/main line	S	3	OFF	-	-	M
Regulation ratio	S	3	ON	-	-	M
Flow rate	S	3	ON	-	-	M
Process power	S	3	ON	-	-	M
act. Power saving. Pump	S	3	OFF	-	4S	M
Energy saving pump	S	3	OFF	-	4S	M
Possibili. Power sav. Pump	S	3	OFF	-	4S, 4M	M
Possibili. Energy sav. Pump	S	3	OFF	-	4S, 4M	M
Nominal temperature difference	S	3	OFF	-	4S, 8R	M
Nominal flow rate	S	3	OFF	-	4S, 8R	M
Nominal pressure difference	S	3	OFF	-	4S, 8R	M
Nominal speed	S	3	OFF	-	4S, 8R	M
Pump speed	S	3	OFF	-	4S, 8R	M
System pressure nom. value	U	3	OFF	-	-	M
System pressure actual value	S	3	OFF	-	-	M
Main line pressure	S	3	OFF	-	ZU, 4S, 8R	M
Pressure difference pump	S	3	OFF	-	-	M
Pressure limitation VL	E	3	OFF	-	4S, 8R	M
Operating hours	S	3	OFF	-	-	M
Operating hours FM 1..4	S	3	OFF	-	-	M
Operating hours FM 5..8	S	3	OFF	-	-	M
Step ramp	S	3	OFF	-	-	M
Remaining time ramp step	S	3	OFF	-	-	M
Current phase L1	U	3	OFF	-	-	M
Current phase L2	U	3	OFF	-	-	M
Current phase L3	U	3	OFF	-	-	M
Voltage 24 VAC	U	3	OFF	-	ZU, 4S, 8R	M
Pump condition	S	3	OFF	-	-	M
Maintenance fluid	S	3	OFF	-	-	M
Maintenance pump	S	3	OFF	-	-	M
Maintenance heating	S	3	OFF	-	-	M
Maintenance cooling	S	3	OFF	-	-	M
Difference main line/external	S	3	OFF	-	-	M
Return line external 1..8	S	3	OFF	-	-	M
Diff. return/main line ext. 1..8	S	3	OFF	-	-	M
Flow rate external 1..8	S	3	OFF	-	-	M

## Control

Process power ext. 1..8	S	3	OFF	-	-	M
Position cooling valve 1	U	3	OFF	-	-	M
Position cooling valve 2	U	3	OFF	-	>100 °C	M
Level tank	S	3	OFF	-	200/250T	M
Temperature cooler	U	3	OFF	-	>100 °C	M
Temperature tank	U	3	OFF	-	200/250T	M
Temperature frequency Converter	U	3	OFF	-	4S, 8R	M
Temperature compensation 1	U	3	OFF	-	-	M
Power pump	S	3	OFF	-	4S, 8R	M
Nom. value pumps (current)	S	3	OFF	-	4S, 8R	M
Output pump	S	3	OFF	-	4S, 8R	M
Production detection	S	3	OFF	-	-	M
<b>Module</b>	S	-	-	-	-	-
Module	S	3	-	-	-	A
<b>External flow meter</b>	S	-	-	-	-	-
External flow meter	S	3	-	-	-	A
<b>Miscellaneous</b>	E	-	-	-	-	-
External flow meter	E	3	active	-	-	A
<b>Variothermal systems</b>	S	-	-	-	-	-
Variothermal systems 1..8	S	3	active	-	-	-
<b>Monitoring</b>	S	-	-	-	-	-
Monitoring	S	3	autom.	-	-	A
Monitoring level	S	3	rough	-	-	M
Reset monitoring	S	3	no	-	-	M
Startup-alarmsuppression	S	3	complete	-	-	A
Alarm contact function	S	3	NO1	-	-	M
Horn volume	S	3	10	-	-	A
Monitoring during functions	U	4	OFF	-	-	A
Output alarm contact	U	4	All	-	-	M
Emergency deact. overheat.	U	4	OFF	s	-	A
<b>Temperature</b>	S	-	-	-	-	-
Upper dev. nominal/actual	S	3	10,0	K	-	M
Lower dev. nominal/actual	S	3	10,0	K	-	M
Difference return/main line	S	3	10,0	K	-	M
Difference main line/external	S	3	OFF	K	-	M
Diff. return/main line ext. 1..8	S	3	10,0	K	-	M
Delay diff. main/return line	S	3	0	min	-	A
Deviation temp. difference.	S	3	2,0	K	4S, 8R	M
<b>Flow rate</b>	S	-	-	-	-	-
Flow rate internal max.	S	3	OFF	L/min	-	M
Flow rate internal min.	S	3	5,0	L/min	-	M
Pump condition min.	S	3	60	%	-	M
Flow rate external 1 .. 8 max.	S	3	OFF	L/min	-	M
Flow rate external 1 .. 8 min.	S	3	1,0	L/min	-	M

## Control

Average Dev. Target-Is Above	S	3	2,0	L/min	4S, 8R	M
Average Dev. Target-Is Below	S	3	2,0	L/min	4S, 8R	M
<b>Tool data</b>	E	-	-	-	-	-
<b>Tool 1-10</b>	E	-	-	-	-	-
Tool no.	E	4	-	-	-	M
Nominal value 1	E	4	-	°C	-	M
Difference return/main line	E	4	-	K	-	M
Difference main line/external	E	4	-	K	-	M
Upper dev. nominal/actual	E	4	-	K	-	M
Lower dev. nominal/actual	E	4	-	K	-	M
Flow rate internal max.	E	4	-	L/min	-	M
Flow rate internal min.	E	4	-	L/min	-	M
Load tool data	E	4	OFF	-	-	M
Save tool data	E	4	OFF	-	-	M
Export tool data	E	4	OFF	-	-	M
Import tool data	E	4	OFF	-	-	M
<b>Level</b>	U	-	-	-	-	-
Level premonition	U	4	5	%	200/250T	M
<b>Setting</b>	S	-	-	-	-	-
<b>Remote</b>	S	-	-	-	-	-
Address	S	3	1	-	-	M
Protocol	S	3	1	-	-	A
Master external control	E	3	autonom.	-	-	A
Transfer rate	E	4	4800	B/s	-	A
Transfer rate CAN Bus	E	4	250	k/s	-	A
Decimal place flow rate CAN	S	4	ON	-	-	A
Parity	E	4	even	-	-	A
Data bit	E	4	8	-	-	A
Stop bit	E	4	1	-	-	A
Serial recording cycle	S	4	1	s	-	A
Delay emergency switch off	U	4	30	s	-	M
Compatibility Profibus to S4	S	4	yes	-	-	A
Profibus node 1	S	4	5	-	-	A
Profibus node 2	S	4	6	-	-	A
Profibus node 3	S	4	7	-	-	A
Profibus node 4	S	4	8	-	-	A
Simulate DFM as device	E	3	OFF	-	-	M
Operate unit as a module	S	3	OFF	-	-	A
<b>TCP/IP Configuration</b>	S	-	-	-	ZO	-
DHCP	U	4	yes	-	ZO	A
DHCP addressing successful	U	4	-	-	ZO	A
IP	U	4	-	-	ZO	A
Subnet mask	U	4	-	-	ZO	A
Standard gateway	U	4	-	-	ZO	A

## Control

Port	U	4	4840	-	ZO	A
Mac Address	U	4	-	-	ZO	A
Em. Shutdown Ses. Timeout	U	4	no	-	ZO	A
<b>Switch clock</b>	E	-	-	-	-	-
Time	E	3	CET	HH:MM	-	A
Date	E	3	CET	-	-	A
Status	E	3	inactive	-	-	A
Day	E	3	Mo-Fr	-	-	A
Switch mode	E	3	OFF	-	-	A
Switch time	E	3	06:00	HH:MM	-	A
<b>Ramp programme</b>	E	-	-	-	-	-
Criterion ramp programme	E	3	nominal	-	-	M
End ramp programme	E	3	OFF	-	-	M
Status	E	3	inactive	-	-	M
Temperature	E	3	0,0	°C	-	M
Time	E	3	00:00	HH:MM	-	M
<b>Controller</b>	E	-	-	-	-	-
Measuring point internal	E	3	Main line	-	-	M
Auto-Tuning	E	3	OFF	-	-	M
Operating mode	E	4	autom.	-	-	M
Parameter P internal	E	4	15	K	-	M
Parameter I internal	E	4	25	s	-	M
Parameter D internal	E	4	OFF	s	-	M
Factor disturbance variable	U	4	OFF	-	-	M
Parameter P external	E	4	150	K	-	M
Parameter I external	E	4	56	s	-	M
Parameter D external	E	4	11	s	-	M
Factor heating/cooling	E	4	20	K	-	M
Limitation heating	E	4	100	%	-	M
Limitation cooling	E	4	100	%	-	M
Filter external sensor	E	4	15,0	s	-	M
Level production detector	E	4	OFF	K	-	M
Nominal value cooler	E	4	55	°C	-	M
Ramp heating	E	2	5,0	K/min	-	M
Function ramp heating	E	2	inactive	-	-	M
Ramp cooling	E	2	5,0	K/min	-	M
Function ramp cooling	E	2	inactive	-	-	M
<b>Date/Time</b>	S	-	-	-	-	-
Time	S	3	CET	HH:MM	-	A
Date	S	3	CET	-	-	A
Time zone	S	3	CET	-	-	A
Time zone Offset UTC	S	3	60	-	-	A
Switch over summer/winter	S	3	autom.	min	-	A
Summer/Winter	S	3	Winter	-	-	A

## Control

Units	S	-	-	-	-	-
Temperature scale	S	2	°C	-	-	A
Flow rate scale	S	2	L/min	-	-	A
Pressure scale	S	2	bar	-	-	A
<b>Recording USB</b>	S	3	-	-	-	-
Serial recording cycle	S	4	1	s	-	A
Activate all values	S	3	OFF	-	-	M
Deactivate all values	S	3	OFF	-	-	M
Nominal value (current)	S	3	ON	-	-	M
Main line	S	3	ON	-	-	M
Return line	S	3	ON	-	-	M
External	S	3	OFF	-	-	M
Deviation actual/nominal	S	3	OFF	-	-	M
Difference return/main line	S	3	OFF	-	-	M
Regulation ratio	S	3	ON	-	-	M
Flow rate	S	3	ON	-	-	M
Process power	S	3	ON	-	-	M
act. Power saving. Pump	S	3	OFF	-	4S	M
Energy saving pump	S	3	OFF	-	4S	M
Possibili. Power sav. Pump	S	3	OFF	-	4S, 4M	M
Possibili. Energy sav. Pump	S	3	OFF	-	4S, 4M	M
Nominal temperature difference	S	3	OFF	-	4S, 8R	M
Nominal flow rate	S	3	OFF	-	4S, 8R	M
Nominal pressure difference	S	3	OFF	-	4S, 8R	M
Nominal speed	S	3	OFF	-	4S, 8R	M
Pump speed	S	3	OFF	-	4S, 8R	M
System pressure nom. value	S	3	OFF	-	-	M
System pressure actual value	S	3	OFF	-	-	M
Main line pressure	S	3	OFF	-	ZU, 4S, 8R	M
Pressure difference pump	S	3	OFF	-	-	M
Pressure limitation VL	E	3	OFF	-	4S, 8R	M
Operating hours	S	3	OFF	-	-	M
Operating hours FM 1..4	S	3	OFF	-	-	M
Operating hours FM 5..8	S	3	OFF	-	-	M
Operating hours GIF	S	3	OFF	-	-	M
Operating hours USR	S	3	OFF	-	-	M
Operating hours heater	S	3	OFF	-	-	M
Operating hours cooler	S	3	OFF	-	-	M
Operating hours pump	S	3	OFF	-	-	M
Operating hours filling pump	S	3	OFF	-	-	M
Step ramp	S	3	OFF	-	-	M
Remaining time ramp step	S	3	OFF	-	-	M
Current phase L1	S	3	OFF	-	-	M
Current phase L2	S	3	OFF	-	-	M
Current phase L3	S	3	OFF	-	ZU, 4S, 8R	M

## Control

Voltage 24 VAC	S	3	OFF	-	-	M
Pump condition	S	3	OFF	-	-	M
Maintenance fluid	S	3	OFF	-	-	M
Maintenance pump	S	3	OFF	-	-	M
Maintenance heating	S	3	OFF	-	-	M
Maintenance cooling	S	3	OFF	-	-	M
Difference main line/external	S	3	OFF	-	-	M
Return line external 1..8	S	3	OFF	-	-	M
Diff. return/main line ext. 1..8	S	3	OFF	-	-	M
Flow rate external 1..8	S	3	OFF	-	-	M
Process power ext. 1..8	S	3	OFF	-	-	M
Position cooling valve 1	S	3	OFF	-	-	M
Position cooling valve 2	S	3	OFF	-	>100 °C	M
Level tank	S	3	OFF	-	200/250T	M
Temperature cooler	S	3	OFF	-	>100 °C	M
Temperature tank	S	3	OFF	-	200/250T	M
Temperature frequency Converter	S	3	OFF	-	4S, 8R	M
Temperature compensation 1	S	3	OFF	-	-	M
Power pump	S	3	OFF	-	4S, 8R	M
Nom. value pumps (current)	S	3	OFF	-	4S, 8R	M
Output pump	S	3	OFF	-	4S, 8R	M
Production detection	S	3	OFF	-	-	M
Total number of alarms	S	3	OFF	-	-	M
Switching cycles alarm relay	S	3	OFF	-	-	M
Switch cycles fill. pump relay	S	3	OFF	-	-	M
Switch cycle X52.1	S	3	OFF	-	-	M
Switch cycle X52.2	S	3	OFF	-	-	M
Switch cycle X52.3	S	3	OFF	-	-	M
Switch cycle X52.4	S	3	OFF	-	-	M
Switch cycle X51.2	S	3	OFF	-	-	M
Switch cycle X51.3	S	3	OFF	-	-	M
Switch cycle X51.4	S	3	OFF	-	-	M
Average heating capacity	S	3	OFF	-	-	M
Average cooler temperature	S	3	OFF	-	-	M
Average cooler temperature	S	3	OFF	-	-	M
Average main line temp.	S	3	OFF	-	-	M
Average return line temp.	S	3	OFF	-	-	M
Average flow	S	3	OFF	-	-	M
Average voltage 24 VAC	S	4	OFF	-	-	M
Number of mould evacuation	S	3	OFF	-	-	M
Number of Auto-Tuning	S	3	OFF	-	-	M
<b>Miscellaneous</b>	<b>S</b>	<b>-</b>	<b>-</b>	<b>-</b>	<b>-</b>	<b>-</b>
Cooling temperature	S	3	35	°C	-	M
Wait after cooling	E	3	OFF	min	-	M

## Control

Time mould evacuation	S	3	-	s	2M, 4M, 4S, ZG	M
Mould evacuation limit temp.	E	3	-	°C	2M, 4M, 4S, ZG	M
Mould evacuation start delay	E	3	90	s	2M, 4M, 4S	A
Pressure relief with unit OFF	E	3	ON	-	2M, 4M, 4S	M
Time pressure relief	E	3	5	s	2M, 4M, 4S	M
Sensor type external sensor	S	3	J/Fe-CuNi	-	ZE	M
Switch over external sensor	E	3	autom.	-	ZE	A
Restart interlock	E	3	OFF	-	-	A
Rinse interval	E	3	OFF	min	-	M
Rinse time	E	3	-	s	-	M
Limitation filling time	E	3	-	s	-	M
Delay flow measuring internal	S	3	-	min	-	M
Temperature limiting	E	3	-	°C	-	M
Safety cut-off temperature	E	3	-	°C	-	A
Max. temperature air relief	U	4	100	°C	-	M
Function nominal value 3	E	3	OFF	-	-	M
Ext. contact read at mains ON	E	3	OFF	-	-	M
Mould evac. with compr. air	U	4	Drain	-	ZG	M
DFM recognition	U	4	integrated	-	-	A
Recognition of hose breakage	E	3	OFF	%	-	M
<b>Profile</b>	S	-	-	-	-	-
User profile	S	3	Standard	-	-	A
Operating release	S	0	2	-	-	A
Code	S	3	1234	-	-	A
Language	S	0	-	-	-	A
Key press volume	S	3	5	-	-	A
<b>Fault finding</b>	S	-	-	-	-	-
<b>Logbook Alarms</b>	S	-	-	-	-	-
Logbook Alarms	S	4	-	-	-	M
<b>Save/Load</b>	S	-	-	-	-	-
Start USB Software Update	E	4	OFF	-	-	A
Recording USB	S	3	OFF	-	-	M
Load configuration data	E	4	OFF	-	-	M
Save configuration data	S	4	OFF	-	-	M
Load parameter data	E	4	OFF	-	-	M
Save parameter data	S	4	OFF	-	-	M
Save error and operation data	S	4	OFF	-	-	M
Save quality test	E	4	OFF	-	-	M
Save Serviceinfo	S	4	OFF	-	-	A

## Operation

# 8 Operation

## 8.1 Mains ON

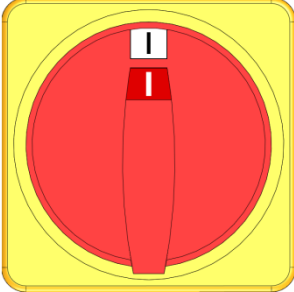

Fig. 25: Main switch

Switch on the temperature control unit as follows:

1. Turn the main switch to position "I".
- Unit initialisation runs. The indication "Ready-to-operate" appears on the display.



## 8.2 Registering new modular units

### Initialisation window

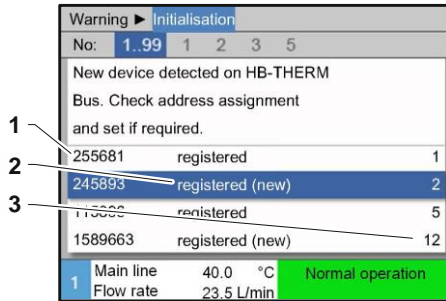

Fig. 26: Initialisation

If a new modular unit is detected, the initialisation window appears at the operating module or individual unit.

Pos. No.	Display
1	GIF-ID
2	Status of modular unit
3	Address of modular unit

### Setting the address

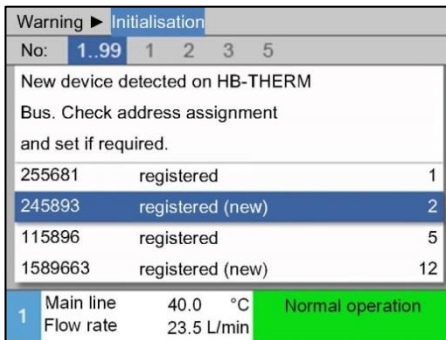

Fig. 27: Setting the address



**NOTE!**

The modular unit is automatically assigned a free address.

Proceed as follows in order to change the address:

1. Select the modular unit and set the desired [Address](#).



**NOTE!**

A set address may only exist once in a network. The menu page can not be exited as long as the address is repeatedly assigned.

### Change address

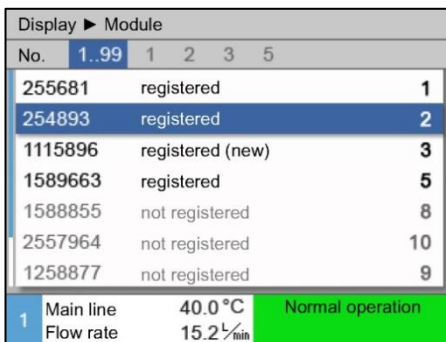

Fig. 28: Display \ Actual value

Proceed as follows in order to subsequently change the address:

1. Display the menu page [Display \ Module](#).
2. Select the modular unit and set the desired [Address](#).



**NOTE!**

The status indicator for the selected modular unit flashes green (fast).

## Operation

### 8.3 Special features for operation of modular units

#### Parameter types:

For modular units, the distinction is made between 2 types of parameter:

- A Module independant (value adjustment only possible for "1..99")
- M Module dependent (value adjustment possible per module)



**NOTE!**

The parameters that can be set module independently or module dependently can be taken from the menu structure (→ page 55)

#### Module No. "1..99" selected

Nominal values			
No.	1..99	1	2 3 4 5 6 7 ...
Nominal value 1		40.0 °C	
Nominal value 2		XXX.X	
4	Main line	40.3 °C	Normal operation
	Flow rate	5.0 1/min	

Fig. 29: Example Nominal values

If the module No. "1..99" is selected, the value of a parameter is displayed with X (grey) as long as the setting is not identical for all modular units.

Otherwise, the value is displayed normally in black. (→ example, Fig. 29)

#### Value adjustment for all modular units

Warning ▶ General settings			
Caution: Value setting effective for all connected devices!			
> Continue value setting with key <b>OK</b>			
> Cancel value setting with key <b>ESC</b>			
7	Main line	40.2 °C	Normal operation
	Flow rate	5.0 1/min	

Fig. 30: Warning text value adjustment

Proceed as follows in order to make a setting for all detected modular units simultaneously:

1. Select Module No. "1..99" with the **←** or **→** key.
2. Select the desired parameter and press the **OK** key.  
→ Confirm warning text with the **OK** key.
3. Set the desired value and confirm with the **OK** key.  
→ Value adjustment takes place simultaneously for all detected modular units.

## 8.4 Operate singular unit as modular unit

An singular unit can be operated as a modular unit. The operation takes place through the higher-level command Thermo-5 or Panel-5.

### Requirement

- Additional equipment ZC
- only one module logged on.
- Software version newer then SW51-2\_1413



#### NOTICE!

The numer of modules currently logged on is displayed under [Display / Module](#)

### Operate unit as module

To operate an singular unit as module, proceed as follows:

1. Switch the unit off with the key.
2. Display the menu page [Setting \ Remote operation](#).
3. Set parameter [Operate unit as module](#) to „ON“.



#### NOTICE!

If the parameter [Operate unit as module](#) is not available, check the requirements.

- The unit starts up again after confirmation of the warning with the key.
- The unit logs on to the higher-level unit Thermo-5 or Panel-5 (→ page 65).

### Operate unit as single unit

To operate the unit again as singular unit, proceed as follows:

1. Switch of the unit through the higher-level command Thermo-5 or Panel-5.
  2. Select [Main menu](#) at the modular unit with the key.
  3. Set parameter [Operate unit as module](#) to „OFF“.
- The unit starts up again after confirmation of the warning with the key.
  - The unit can be operated again as an singular unit.

## Operation

### 8.5 Switching on

#### 8.5.1 Normal operation

##### Switch on individual unit



Fig. 31: Basic display individual unit

##### Switch on modular units individually



Fig. 32: Basic display

##### Switch on all modular units

Tu 2010-04-13, 09:10		HB-THERM						
No:	All	1	2	3	4	...	[Left Arrow]	[Right Arrow]
No	Nom	Act	1/2 min	Main	Ret	H/C		
1	OFF							
2	OFF							
3	OFF							
4	OFF							
5	OFF							
6	OFF							
7	OFF							
8	OFF							
2	Main line Pressure	25.0 °C	0.0 bar	Ready to operate				

Fig. 33: Table view

Switch on normal operation as follows:

1. Press the key.  
→ The unit starts in the defined operating mode. If necessary, the unit is automatically filled and vented.
2. Ensure that the functions [Mould evacuation](#), [Leak stopper](#), [2nd nominal value](#) and [Cooling](#) are switched off.

Switch on normal operation as follows:

1. Select the Module No. with the or key.
2. Press the key.  
→ The unit starts in the defined operating mode. If necessary, the unit is automatically filled and vented.
3. Ensure that the functions [Mould evacuation](#), [Leak stopper](#), [2nd nominal value](#) and [Cooling](#) are switched off.



**NOTE!**

If modular units are already in operation, all modular units are switched off by pressing the key.

Switch on normal operation as follows:

1. Select Module No. "1..99" with the or key.
2. Press the key.  
→ All units start in the defined operating mode. If necessary, the units are automatically filled and vented.
3. Ensure that the functions [Mould evacuation](#), [Leak stopper](#), [2nd nominal value](#) and [Cooling](#) are switched off.

### 8.5.2 External sensor

#### Function (additional equipment ZE)

In order to precisely control the temperature of a consumer, an external temperature sensor can be connected to the unit:

#### Pre-selection of external sensor type

Setting ▶ Miscellaneous	
Wait after cooling	OFF
Time mould evacuation	45 s
Mould evacuation limit temp.	70 °C
Mould evacuation start delay	90 s
Pressure relief with unit OFF	ON
Time pressure relief	5 s
Sensor type external sensor	J/Fe-CuNi
Switch over external sensor	manual
1 Main line 25.0 °C Ready to operate	
Flow rate --1/min	

Fig. 34: Setting sensor type for external sensor



**NOTE!**

The sensor type Pt 100 is automatically recognised and adjusted. All other sensor types have to be set manually.

The external sensor type is set as follows:

1. Display the menu page **Setting \ Miscellaneous**.
2. Set parameter **Sensor type external sensor** to the connected sensor type.

#### Switching to external sensor

Setting ▶ Miscellaneous	
Wait after cooling	OFF
Time mould evacuation	45 s
Mould evacuation limit temp.	70 °C
Mould evacuation start delay	90 s
Pressure relief with unit OFF	ON
Time pressure relief	5 s
Sensor type external sensor	J/Fe-CuNi
Switch over external sensor	autom.
1 Main line 25.0 °C Ready to operate	
Flow rate --1/min	

Fig. 35: Switch over external sensor

When recognised, the unit automatically switches over to a connected external sensor. If this is not desired, make the following setting:

1. Display the menu page **Setting \ Miscellaneous**.
2. Set parameter **Switch over external sensor** to "manual".



**NOTE!**

On breakage of the external sensor, with the setting **Switch over external sensor** "autom", automatic switching is made to the internal measuring point; with the setting "manual", an error message results.

#### Switching control to external sensor on or off manually

Functions	
Cooling	
Mould evacuation	
External sensor	✓
Remote	
Leak stopper	
2nd nominal Value	
Switch clock	
Ramp programme	
1 Main line 25.0 °C Ready to operate	
Flow rate --1/min	

Fig. 36: Switching on the external sensor



**NOTE!**

Switching control to the external sensor on or off manually is only necessary when the parameter **Switch over external sensor** is set to "manual".

Proceed as follows in order to switch control to the external sensor on or off manually:

1. Display menu page **Functions**.
2. Select function **External sensor** and activate or deactivate with the key.

The activated function is indicated with the symbol.

## Operation

### Production detection

Setting ▶ Controller		
Parameter D external	11 s	
Factor heating/cooling	20 K	
Limitation heating	100 %	
Limitation cooling	100 %	
Filter external sensor	15.0 s	
Level production detector	15 K	
Ramp heating	OFF	
Ramp cooling	OFF	
1 Main line	25.0 °C	Ready to operate
Pressure	0.0 bar	

Fig. 37: Level production detector

For applications with the sensor close to the cavity, physically caused temperature deviations due to production interruptions can occur. When production detection is switched on, switchover is made to main line control on production interruption. Temperature deviations are avoided.

Proceed as follows in order to switch production detection on and off:

1. Display the menu page **Setting \ Controller**.
2. Set parameter **Level production detector** to "15 K".



**NOTE!**

The default setting is "OFF".

### Sensor breakage external sensor

On breakage of the external sensor, with the setting **Switch over external sensor** "autom", automatic switching is made to the internal measuring point; with the setting "manual", an error message results.

### 8.5.3 Mode 2nd nominal value

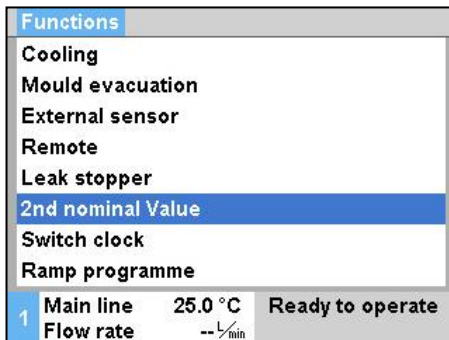



Fig. 38: 2. Switch on nominal value



#### NOTE!

The function **2nd nominal value** is only displayed when the parameter **Nominal value 2** on menu page **Nominal values** is set to a value greater than "0.0".

Switch on the mode 2nd nominal value as follows:

1. Display menu page **Functions**.
2. Select the parameter **2nd nominal value** and activate with the  key.

The activated function is indicated with the  symbol.

- The unit switches over to the mode 2nd nominal value. The nominal value 2 is used for the controller.

# Operation

## 8.5.4 Remote mode

In remote control mode the temperature control unit is controlled by external signals. Two types of external signal are supported.



**NOTE!**

For the pin assignment of the various interface cables → page 134.

### External control connection (additional equipment ZB)

By means of a potential-free external contact, the temperature control unit can be

- switched on and off.
- switched between nominal value 1 and 2.
- the ramp programme can be switched on and off.



**NOTICE!**

The function **Remote** must not be switched on for external control.

### Turn remote mode on or off

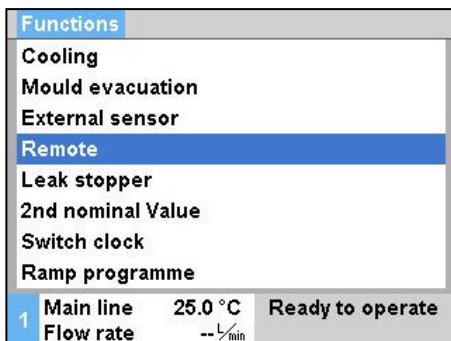

Fig. 39: Remote mode

Proceed as follows in order to switch the remote mode on and off:

1. Display menu page **Functions** .
2. Select the function **Remote** and activate or deactivate with the key.

The activated function is indicated with the symbol.

→ When the remote mode is switched on, the symbol appears on the basic display.



**NOTE!**

When the remote mode is active, all parameters and functions that are defined via the protocol are blocked at the unit.



**Remote mode settings  
(additional equipment ZD, ZC,  
ZP, ZO)**

Setting ▶ Remote	
Address	1
Protocol	1
Master external control	autonom.
Transfer rate	4800
Transfer rate CAN Bus	250
Parity	even
Data bit	8
Stop bit	1
1 Main line 25.0 °C Ready to operate	
Flow rate --L/min	

Fig. 40: Set address, protocol

Operation and monitoring of the temperature control unit can take place via the serial interface.

The following settings must be made in order to communicate with an external controller:

1. Display the menu page [Setting \ Remote operation](#) .
2. Set parameter [Address](#) to the desired value.
3. Set parameter [Protocol](#) to the desired value.



**NOTE!**

*A set address may only exist once in a network.*

**Network settings (Additional  
equipment ZO)**

... ▶ TCP/IP Configuration	
DHCP	yes
DHCP addressing successful	yes
IP	10.100.0.154
Subnet mask	255.255.255.0
Standard gateway	10.100.0.1
Port	4840
Mac Address	ff:cc:dd:11:22:33
1 Main line 40.0 °C Ready to operate	
Pressure 0.0 bar	

Fig. 41: Network settings

The following settings must be made in order to communicate with an external controller through the network (OPC UA):

1. Select the menu page [Setting \ Remote \ TCP/IP Configuration](#).
2. Make network settings.

If a DHCP server is available, the [DHCP](#) parameter must be set to "yes". Then an IP address will be automatically procured from the DHCP server.

If no DHCP server is available, the settings with the [IP](#), [Standard gateway](#) and [Subnet mask](#) parameters must be set manually.



**NOTICE!**

*The settings will be applied on leaving the menu. Any active connections will be automatically disconnected.*

*The OPC UA protocol is active and data can always be read regardless of the protocol set. In order to be able to write additional data, the OPC UA protocol 19 must be set and the remote operation must be activated.*

## Operation

Protocol	Used for
HB	Internal communication (only use when setting is operate unit as module)
0	Recording text
1	Arburg, Billion, Bühler, Dr. Boy, Ferromatik Milacron, KraussMaffei, Negri Bossi, Sumitomo Demag, Wittmann Battenfeld, Zhafir
2	Sumitomo Demag (CAN)
4	Engel, Haitian
5	Stork
9	EUROMAP 66 (CANopen; Netstal, etc.)
14	MODBUS (RTU-Mode)
15	Profibus-DP
16	SPI (9600 8-N-1; 1. Adr. =1)
19	EUROMAP 82.1 (OPC UA)

## 8.6 Switching off

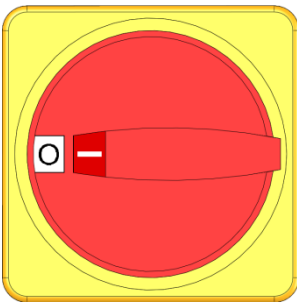

Fig. 42: Main switch

### Switch-off without pressure relief

Setting ▶ Miscellaneous	
Cooling temperature	35 °C
Wait after cooling	OFF
Time mould evacuation	45 s
Mould evacuation limit temp.	70 °C
Mould evacuation start delay	90 s
Pressure relief with unit OFF	ON
Time pressure relief	5 s
Sensor type external sensor	J/Fe-CuNi
1 Main line	25.0 °C Ready to operate
Flow rate	-- 1/min

Fig. 43: Pressure relief with unit OFF

### Switching off with mould evacuation

After use, switch the temperature control unit off as follows:

1. Press the  key.
  - The temperature control unit cools until the main and return line temperature is lower than the set safety cut-off temperature.
  - Afterwards, a pressure release is carried out.
  - After this, the temperature control unit switches off. In the operating mode display, "Ready to operate" is indicated.
2. Turn the main switch to position "0".

In order to switch the temperature control unit off without pressure relief, make the following settings:

1. Display the menu page [Setting \ Miscellaneous](#).
2. Set parameter [Pressure relief with unit OFF](#) to "OFF".

In order to switch the temperature control unit off with mould evacuation, make the following settings:

1. Display the menu page [Settings \ Miscellaneous](#).
2. Set the parameter [Pressure relief with unit OFF](#) to "Mould evacuation".

## Operation

### 8.6.1 Cooling down and switching off

Setting ▶ Miscellaneous	
Cooling temperature	35 °C
Wait after cooling	OFF
Time mould evacuation	45 s
Mould evacuation limit temp.	70 °C
Mould evacuation start delay	90 s
Pressure relief with unit OFF	ON
Time pressure relief	5 s
Sensor type external sensor	J/Fe-CuNi
1 Main line	25.0 °C Ready to operate
Flow rate	-- L/min

Fig. 44: Cooling temperature

Functions	
Cooling	
Mould evacuation	
External sensor	
Remote	
Leak stopper	
2nd nominal Value	
Switch clock	
Ramp programme	
1 Main line	25.0 °C Ready to operate
Pressure	0.0 bar

Fig. 45: Switch on cooling

If necessary, before switching on the cooling, set the cooling temperature and the cooling duration:

1. Display the menu page **Setting \ Miscellaneous**.
2. Set parameter **Cooling temperature** to the desired value.
3. Set parameter **Wait after cooling** to the desired value.

Switch on cooling as follows:

1. Display menu page **Functions**.
2. Select the parameter **Cooling** and activate with the **OK** key.  
The activated function is indicated with the  symbol.



**NOTE!**

*If, after activating the cooling function, the mould evacuation function is activated, the unit carries out mould evacuation before the unit is switched off.*

## 8.6.2 Mould evacuation

Setting ▶ Miscellaneous	
Cooling temperature	35 °C
Wait after cooling	OFF
<b>Time mould evacuation</b>	<b>45 s</b>
Mould evacuation limit temp.	70 °C
Mould evacuation start delay	90 s
Pressure relief with unit OFF	ON
Time pressure relief	5 s
Sensor type external sensor	J/Fe-CuNi
1 Main line	25.0 °C Ready to operate
Flow rate	-- ↘ /min

Fig. 46: Setting mould evacuation time

Functions	
Cooling	
<b>Mould evacuation</b>	
External sensor	
Remote	
Leak stopper	
2nd nominal Value	
Switch clock	
Ramp programme	
1 Main line	25.0 °C Ready to operate
Flow rate	-- ↘ /min

Fig. 47: Switch on mould evacuation

If necessary, before switching on mould evacuation, set the desired mould evacuation duration:

1. Display the menu page **Setting \ Miscellaneous**.
2. Set parameter **Time mould evacuation** to the desired value.

Switch on mould evacuation as follows:

1. Display menu page **Functions**.
2. Select the function **Mould evacuation** and activate with the **OK** key.

The activated function is indicated with the  symbol.

- Cooling down to 70 °C takes place before the mould evacuation process.
- Consumers and supply hoses are sucked empty and depressurised.
- Afterwards, the temperature control unit is switched off.



### NOTE!

Before opening connections between the temperature control unit and the consumer, check that the pressure is 0 bar.

The evacuation volume is led to the cooling or system water outlet.

## Operation

### 8.6.3 Mould evacuation with compressed air

#### Additional equipment ZG

With this function, all connected consumers and supply hoses are emptied with compressed air and depressurised. Switch on mould evacuation (→ page 77).

#### Emptying into cooling or system water outlet

Setting ▶ Miscellaneous	
Rinse time	0.5 s
Limitation filling time	30 s
Temperature limiting	105 °C
Safety cut-off temperature	70 °C
Max. temperature air relief	100 °C
Function nominal value 3	OFF
Ext. contact read at mains ON	OFF
Mould evac. with compr. air	Drain
1 Main line	25.0 °C
Pressure	0.0 bar
Ready to operate	

Fig. 48: Mould evac. with compr. air

Set the outlet for emptying as follows:

1. Display the menu page [Setting \ Miscellaneous](#).
2. Set parameter [Mould evac. with compr. air](#) to "Drain".

#### Emptying to compressed air outlet

Set the outlet for emptying as follows:

1. Display the menu page [Setting \ Miscellaneous](#).
2. Set parameter [Mould evac. with compr. air](#) to "Tank".



#### NOTE!

Connect depressurised tank or drain to the compressed air outlet.

## 8.7 Emergency stop

In dangerous situations, the unit must be stopped as quickly as possible and the power supply switched off.

### Emergency stop

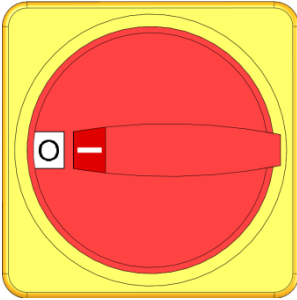

Fig. 49: Main switch

### After rescue measures

Proceed as follows in a hazardous situation:

1. Turn the main switch to "0".
2. Disconnect from the mains or disconnect all phases of the external power supply and secure them against being switched on again.
3. If necessary, bring people out of the danger area and carry out first-aid.
4. If necessary, alert a doctor and the fire brigade.
5. Inform the responsible person on site.
6. If required by the severity of the emergency, inform the responsible authorities.
7. Commission qualified personnel to do the fault rectification.



#### **WARNING!**

#### **Danger of life due to premature re-activation!**

On restarting there is a danger of fatal injury for people in the danger area.

Therefore:

Before restarting, ensure that there are no persons in the danger area.

8. Before recommissioning, check the unit for perfect functioning.

## Operation

### 8.8 Define access rights

#### 8.8.1 Set user profile

##### Function

In order to avoid operating error and to improve clarity, menus, functions and parameters are suppressed corresponding to the set user profile.

##### Differentiating user profiles

A differentiation is made between the following user profiles.

User profile	Code	User/Characteristic
Standard	S	For the standard user
Enhanced	E	For the machine setter
Support	U	For the manufacturer and service personnel authorised by them

##### Set user profile

Profile			
User profile		Support	
Operating release		2	
Code			
Language		English	
Key press volume		5	
1	Main line	25.0 °C	Ready to operate
	Flow rate	--L/min	

Fig. 50: User profile

The user profile can be set as follows:

1. Display menu page [Profile](#) .
2. Select parameter [User profile](#).
3. Enter access code.
4. Set desired user profile.



# Operation

## 8.8.2 Set operating release



### Function

With the operating release level, it is determined which functions or values can be changed. If it is attempted to change locked values, a corresponding warning text appears on the display.

### Levels of operating release

Level	Operating release
0	No access
1	Access to functions
2	Access to nominal values
3	Access to settings and monitoring
4	Access to service

### Once-only operating release

1. Select locked parameter and press the  key, warning text appears on the display.
2. Press the  key.
3. Enter access code.

 **NOTE!**  
*The once-only operating release is valid until the basic display reappears.*

### Permanent operating release

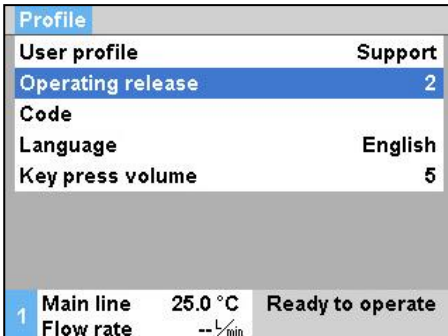

1. Display menu page **Profile** .
2. Select parameter **Operating release** and press the  key.
3. Enter access code.
4. Set parameter **Operating release** to the desired value.

Fig. 51: Operating release

## Operation

### 8.8.3 Change access code

The access code is a four-digit numeral and comprises the numbers 1, 2, 3 and 4.

When the unit is delivered, the access code is 1234.



**NOTE!**

*For protection against misuse of the unit, change the access code immediately after commissioning. If the current code is lost, please contact the nearest HB-Therm representative.*

#### Change access code

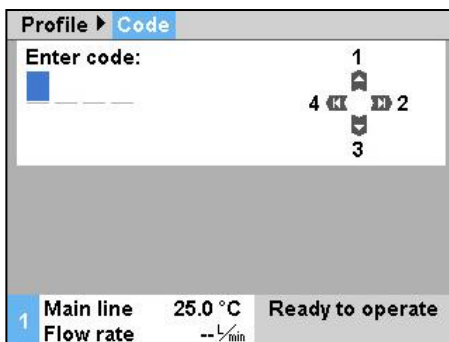

Fig. 52: Enter code

To change the access code:

1. Display menu page **Profile** .
2. Select the parameter **Code** and press the **OK** key.
3. Enter existing access code.
4. Enter new access code.
5. Confirm new access code.

## 8.9 Settings

### 8.9.1 Setting time zone, date and time

#### Set time zone

By default, date and time of the unit are set to Central European Time (CET) at delivery. To accommodate for different time zones, date and time must be set manually before commissioning. In this case, please proceed as follows:

1. Open the **Setting \ Date / Time** menu page.
2. Set the **Time zone** parameter to the appropriate time zone.

#### Set date and time

Setting ▶ Date / Time			
Time			11:28
Date		We 2017-08-02	
Time zone		CET	
Switch over summer/winter		autom.	
Time zone Offset UTC		01:00	
1	Main line Pressure	25.0 °C 0.0 bar	Ready to operate

Fig. 53: Setting date / time

If the required time zone is not available in the parameter list, date and time will have to be set as follows:

1. Open the **Setting \ Date / Time** menu page.
2. Set the **Time** parameter to the appropriate value.
3. Set the **Date** parameter to the appropriate value.



#### NOTICE!

*If the required time zone is not available, then switching between summer and winter time will have to be done manually.*

#### Set switching to summer and winter time

For the selectable time zones, switching between summer and winter time is done automatically.

Set the following to suppress the automatic switch:

1. Open the **Setting \ Date / Time** menu page.
2. Set the **Switch to summer/winter** parameter to "manual".

## Operation

### 8.9.2 Define internal measuring points

#### Function

Main and return line sensors are integrated in the temperature control unit as standard.

One of these two measuring points is fed to the internal controller as the actual value.

#### Pre-selection of internal temperature sensor

Setting ▶ Controller	
Measuring point internal	Main line
Auto-Tuning	OFF
Operating mode	autom.
Parameter P internal	15 K
Parameter I internal	25 s
Parameter D internal	OFF
Factor disturbance variable	OFF
Parameter P external	150 K
1 Main line	25.0 °C
Flow rate	--L/min
Ready to operate	

Fig. 54: Setting internal measuring point

Proceed as follows to switch over the internal temperature sensor:

1. Display the menu page [Setting \ Controller](#).
2. Set parameter [Measuring point internal](#) to the desired value.

### 8.9.3 Set switch clock

#### Function

With the switch clock, the temperature control unit can be switched on and off at pre-programmed times and days.

#### Turn switch clock on or off.

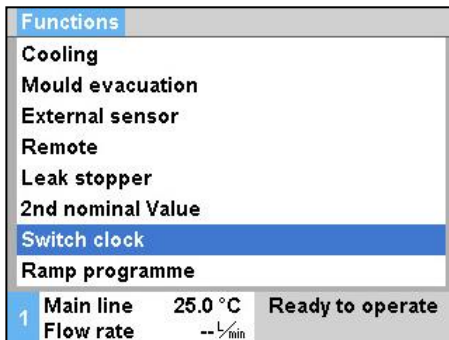

Fig. 55: Turn switch clock on or off.

Proceed as follows in order to turn the switch clock on or off:

1. Display menu page **Functions**.
2. Select the function **Switch clock** and activate or deactivate with the **OK** key.

The activated function is indicated with the symbol.

→ As soon as the set switch-on or switch-off time has been reached, the unit automatically switches on or off.

→ The active switch clock is indicated with the symbol on the basic display.

#### Programme switch-on and switch-off times

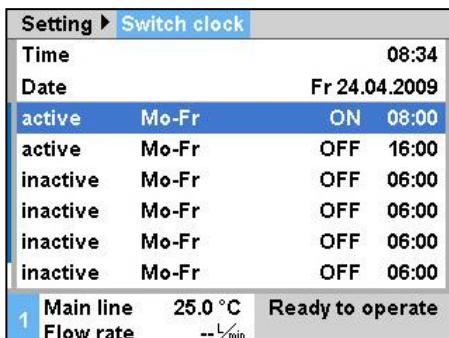

Fig. 56: Switch clock settings

Proceed as follows in order to programme the switch-on and switch-off times for one day:

1. Display the menu page **Setting \ Switch clock**.
2. Set parameter **Day** to the desired day(s).
3. Set parameter **Switch time** to the desired time for the selected day.



**NOTE!**

If a day is set to "inactive", the programmed switch time has no effect. If all days are set to "inactive", the function **Switch clock** will not be displayed on the **Functions** menu page.

## Operation

### 8.9.4 Set ramp programme

#### Function

With the ramp programme, a defined temperature profile comprising up to ten steps can be run. When the ramp programme runs, the nominal value continuously changes corresponding to the temperatures and times defined per programme step.

#### Set ramp programme

Setting ▸ Ramp programme			
Criterion ramp programme			Nominal
End ramp programme			OFF
Step 1	active	40.0 °C	01:00
Step 2	active	49.0 °C	00:10
Step 3	inactive	0.0 °C	00:00
Step 4	inactive	0.0 °C	00:00
Step 5	inactive	0.0 °C	00:00
Step 6	inactive	0.0 °C	00:00
1 Main line	25.0 °C	Ready to operate	
Flow rate	--L/min		

Fig. 57: Ramp programme settings

Proceed as follows in order to set the ramp programme individually:

1. Display the menu page **Setting \ Ramp programme**.
2. Set parameter **Criterion ramp programme** to the desired value.
  - **Criterion ramp programme** defines whether the temperature has to reach only the nominal value or also the actual value before switching to the next step.
3. Set parameter **End ramp programme** to the desired value.
  - **End ramp programme** defines the procedure after conclusion of the ramp programme.
    - "OFF" → Switch unit off
    - "Restart" → continue with step 1
    - "Go on" → continue with the the last nominal value
4. Set the desired **Temperature** and **Time** for each step.



**NOTE!**

*If a step is set to "inactive", the programmed values have no effect on the ramp programme. If all steps are set to "inactive", the ramp programme will not be displayed in the **Functions** menu.*

### Switch on ramp programme

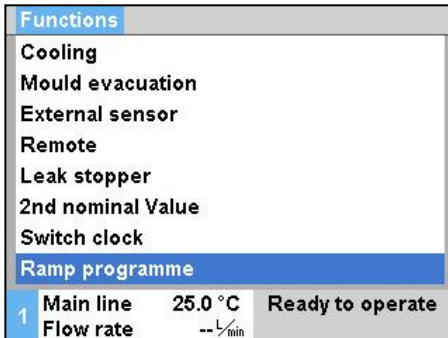

Fig. 58: Ramp programme

Proceed as follows in order to switch on the ramp programme:

1. Display menu page **Functions**.
2. Select the function **Ramp programme** and activate or deactivate with the **OK** key.

The activated function is indicated with the symbol.

→ The ramp programme begins with step 1. In the basic display, the symbol appears and the next to it the current programme step number.



#### NOTE!

The ramp programme can also be switched on and off via an external potential-free contact (additional equipment ZB)

### Interrupt ramp programme

Proceed as follows in order to interrupt the running ramp programme:

1. Display menu page **Functions**.
2. Select the function **Ramp BREAK** and activate or deactivate with the **OK** key.

The activated function is indicated with the symbol.

## Operation

### 8.9.5 Cyclical change-out of the system water

During operation, water fed in through the cold-water or system-water feed stays in the heat-transfer circuit. You are therefore advised to switch on the cyclical change-out of the system water if you are using a Treat 5 water-treatment device or a water-treatment system.



**ATTENTION!**  
**Incorrect settings cause damage.**

Using the cyclical change-out of the system water with poor-quality water can result in contamination and calcification.

Therefore:

- Do not switch on cyclical change-out of the system water unless your water is well treated.

#### Switching the cyclical change-out of the system water on or off

Setting ▶ Miscellaneous			
Time pressure relief			5 s
Sensor type external sensor		J/Fe-CuNi	
Switch over external sensor		autom.	
Restart interlock		OFF	
Rinse interval		30 min	
Rinse time		0.5 s	
Limitation filling time		30 s	
Temperature limiting		105 °C	
1	Main line	25.0 °C	Ready to operate
	Pressure	0.0 bar	

Fig. 59: Setting the rinsing intervals

To switch the cyclical change-out of the system water on or off, proceed as follows:

1. Display the **Setting \ Miscellaneous** menu page.
2. Set **Rinse interval** parameter to the desired value.



**NOTE!**

*Under normal operating conditions, and with the recommended rinsing interval of 30 minutes, the circuit medium is changed out in 1-2 days.*

*The default setting is "OFF" (change-out of the system water switched off).*



## 8.10 Process monitoring

### 8.10.1 Limit value monitoring

#### Function

After each unit start-up, the limit values for process monitoring are automatically determined and set in the standard settings according to the set monitoring level.



**NOTICE!**

*If the limit values have not been set, the operating mode indicator flashes green.*

#### Cancelling monitoring

Monitoring			
No:	All	1	2 3 4
Temperature			▶
Flow rate			▶
Tool data			▶
Level			▶
Monitoring		autom.	
Monitoring level		rough	
Reset monitoring		no	
1	Main line	39.5 °C	Ready to operate
	Pressure	0.4 bar	

Fig. 60: Monitoring

If automatic limit value calculation is not desired, make the following setting:

1. Open menu page **Monitoring**.
2. Set parameter **Monitoring** to "manual" or "OFF".



**NOTICE!**

*If monitoring is set to "OFF", the process will not be monitored. This can lead to unnecessary connections.*

#### Reference values for manual limit value settings

The following limit values can be used for support:

Reference value for	Temperature deviation	Temperature difference
Precision parts	3–5 K	2–3 K
Non-precision parts	5–10 K	3–5 K

#### Reset monitoring

Monitoring			
Temperature			▶
Flow rate			▶
Tool data			▶
Monitoring		autom.	
Monitoring level		rough	
Reset monitoring		no	
Startup-alarmsuppression		complete	
Alarm contact function		NO1	
1	Main line	25.0 °C	Ready to operate
	Pressure	0.0 bar	

Fig. 61: Reset monitoring

Proceed as follows in order to automatically adjust the limit values during operation:

1. Open menu page **Monitoring**.
2. Set parameter **Reset monitoring** to "yes".
3. Press the key .



**NOTICE!**

*Limit values that are set to "OFF" will not be adjusted.*

## Operation

### Set monitoring level

Monitoring	
Temperature	▶
Flow rate	▶
Tool data	▶
Monitoring	autom.
Monitoring level	rough
Reset monitoring	no
Startup-alarm suppression	complete
Alarm contact function	NO1
1 Main line	25.0 °C Ready to operate
Pressure	0.0 bar

Fig. 62: Monitoring level

The tolerance range is determined with the parameter **Monitoring level** and can be adapted as follows:

1. Display menu page **Monitoring**.
2. Set parameter **Monitoring level** to "fine", "middle" or "rough".

The limit values for temperature, flow rate and pressure are calculated according to the following table:

Designation	Monitoring level						Basis
	fine		middle		rough		
	Factor	min	Factor	min	Factor	min	
Upper dev. nominal/actual	0.01	1.0 K	0.05	5.0 K	0.1	10 K	Nominal temperature
Lower dev. nominal/actual	0.01	1.0 K	0.05	5.0 K	0.1	10 K	
Difference main/return line	1.1	1.0 K	1.5	5.0 K	2.0	10 K	Difference main and return line
Diff. main line/external	1.1	1.0 K	1.5	5.0 K	2.0	10 K	Difference main line/external
Flow rate internal max.	1.2	-	1.4	-	1.7	-	Flow rate internal
Flow rate internal min.	0.8	0.5 l/min	0.6	0.5 l/min	0.3	0.5 l/min	
Flow rate external 1..8 max.	1.2	-	1.4	-	1.7	-	Flow rate external 1..8
Flow rate external 1..8 min.	0.8	0.5 l/min	0.6	0.5 l/min	0.3	0.5 l/min	

### 8.10.2 Monitor pump wear

**Function**  
(additional equipment ZU)

With pump wear monitoring, the condition of the pump is constantly monitored. On falling below the defined value for parameter **Pump condition min.**, the system issues a warning message and this is indicated on the basic display with the  symbol.

#### Display current pump condition

Display ▶ Actual value	
Current phase L1	0.0 A
Current phase L2	0.0 A
Current phase L3	0.0 A
Pump condition	--%
Maintenance fluid	--%
Maintenance pump	--%
Maintenance heater	--%
Maintenance cooler	--%
1 Main line	32.1 °C
Flow rate	-- $\frac{L}{min}$
Ready to operate	

Fig. 63: Pump condition

The current pump condition is displayed as follows:

1. Display the menu page **Display \ Actual value**.
2. Read off the value for parameter **Pump condition**.



**NOTE!**

The condition of the pump is only calculated and displayed approximately 30 minutes after switching on the unit. "--%" is displayed in front of it.

#### Set pump condition limit value

Monitoring ▶ Flow rate	
Flow rate internal max.	OFF
Flow rate internal min.	--
Condition pump min.	60%
1 Main line	40.2 °C
Flow rate	-- $\frac{L}{min}$
Ready to operate	

Fig. 64: Pump condition limit value min.

Proceed as follows in order to set the limit value for pump condition:

1. Display the menu page **Monitoring \ Flow rate**.
2. Set parameter **Pump condition min.** to the desired value.

## Operation

### 8.10.3 Optimise controller

#### Function

Optimisation of the regulation parameters is triggered automatically after determining a change in the temperature control circuit or on detection of abnormal regulation.

Normally, manual setting of the regulation parameter is not necessary.

#### Automatic controller optimisation

Temperature fluctuations may occur during automatic controller optimisation. The optimisation process is indicated on the basic display with the **AT** symbol.

If the cooling or heating capacity is insufficient to carry out controller optimisation, then this will be aborted after 30 minutes.



#### **NOTE!**

*If, despite controller optimisation, the regulation quality is inadequate, please contact the nearest HB-Therm representative (→ [www-hb-therm.ch](http://www-hb-therm.ch)).*

## 8.11 Explorer window

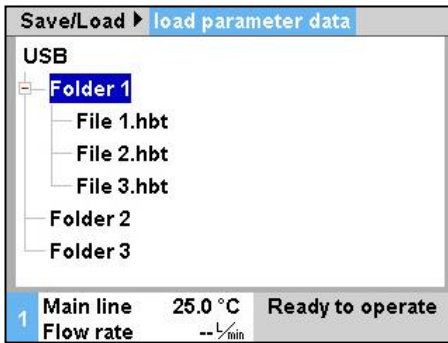





Fig. 65: Example Explorer window

The Explorer window displays the directories and files on the inserted USB data carrier.

- Directories with  are opened with the  key.
- Directories with  are closed with the  key.



**NOTE!**

Depending on the number of files and directories on the USB data carrier, it can take several minutes before the directory structure is displayed.



**NOTE!**

From the operating panel it is not possible to create, delete or process directories on the USB data carrier.

## Operation

### 8.12 Save/Load

#### Function

With the menu page **Save/Load**, various data can be saved to a USB data carrier or loaded from a USB data carrier. With this function, it is possible to transfer data from one unit to another unit. In case of failure, the service information can be stored on an USB device for fault diagnosis by a representative of HB-Therm.



**WARNING!**  
**Damage due to wrong settings!**

Loading wrong parameter or configuration data can lead to malfunction or total breakdown.

Therefore:

- Only load data that is intended for the unit.



**NOTICE!**

*The relevant user profile is saved in the file when saving the parameter. During the subsequent charging, only the relevant parameter with the profile saved and its subordinates is charged.*



**NOTICE!**

*Only FAT32 formatted USB data carriers are supported.*

#### Saving data

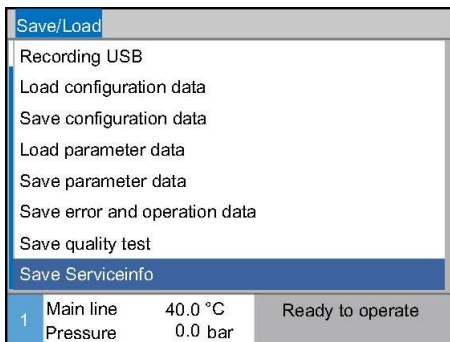

Fig. 66 Saving data

Proceed as follows in order to save data from the unit to a USB data carrier:

1. Display menu page **Save/Load**.
  2. Connect USB data carrier to front connector.
  3. Select the data to be saved and confirm with the **OK** key.
  4. In the Explorer window, select the directory and confirm with **OK**.
- The file is saved to the selected directory on the USB data carrier.



**NOTICE!**

*Saving service information includes all service relevant data (configuration-, parameter etc.) that are necessary for a fault diagnosis.*

**Loading data**

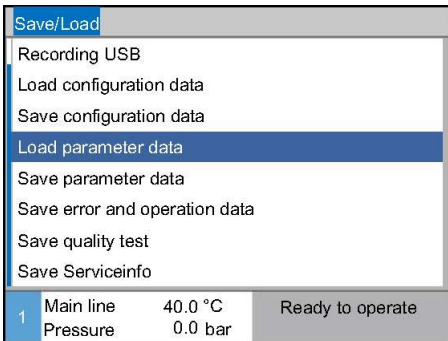

Fig. 67 Loading data

Proceed as follows in order to load data to the unit from a USB data carrier:

1. Display menu page **Save/Load**.
  2. Connect USB data carrier to front connector.
  3. Select the data to be loaded and confirm with the **OK** key.
  4. In the Explorer window, select the directory and file and confirm with **OK**.
- The data is loaded to the unit. If loaded values are outside the permissible range, then these are reset to the standard settings.

**File name**

The unit automatically creates file names on the USB data carrier according to the following examples:

**Serviceinfo**

Exa. **Serviceinfo\_2017-03-10\_15-26-08**

**Configuration data**

Exa. **HB 160 Z1 8 4M A2 400 1 [1].csv**

**Parameter data**

Exa. **Par HB 160 Z1 1 [1].csv**

**Error and Operation data**

Exa. **BD HB 160 Z1 1 [1].csv**

<sup>1</sup>An index is automatically added when the file name already exists.

# Operation

## 8.12.1 Tool data

### Function

A maximum of 10 tool data sets with defined tool-specific parameters can be stored in the unit.

### Tool-specific parameters

A tool data set comprises the following parameters:

Parameter	Comment
Tool No.	Tool name, max. 7 characters
Nominal value 1	
Upper dev. nominal/actual	
Lower dev. nominal/actual	
Difference main/return line	
Difference main line/external	
Flow rate internal max.	
Flow rate internal min.	

### Save tool data

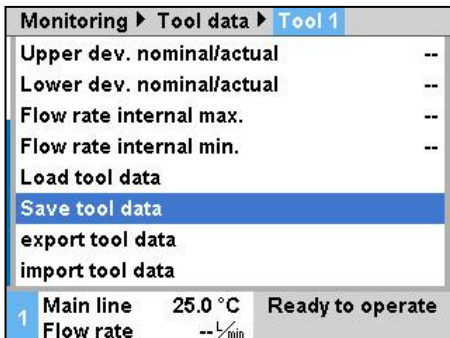

Fig. 68: Save tool data

Proceed as follows in order to save the current limit value settings (temperature and flow rate) as well as nominal value 1 to the selected tool data set:

1. Display menu page **Monitoring \ Tool data \ Tool 1..10**.
  2. Select the parameter **Save tool data** and confirm with the **OK** key.
- The limit values (temperature and flow rate) and nominal value 1 are saved to the selected tool data set.

### Load tool data

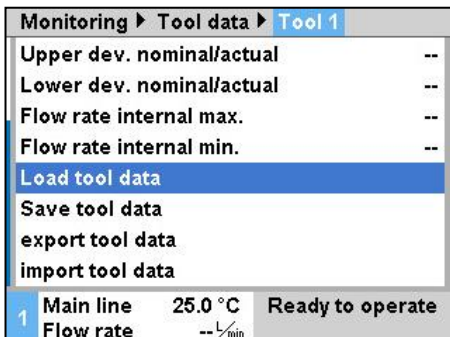

Fig. 69: Load tool data

Proceed as follows in order to load the selected tool data set as limit values (temperature and flow rate) or nominal value 1:

1. Display menu page **Monitoring \ Tool data \ Tool 1..10**.
  2. Select parameter **Load tool data** .
  3. Press the **OK** key.
- The parameters from the selected tool data set are loaded as limit values or nominal value 1.
- Parameters that are set to "--" will not be loaded.

**i** **NOTE!**  
When loading tool data, monitoring is automatically set to "manual".



**Operation**

**Export tool data**

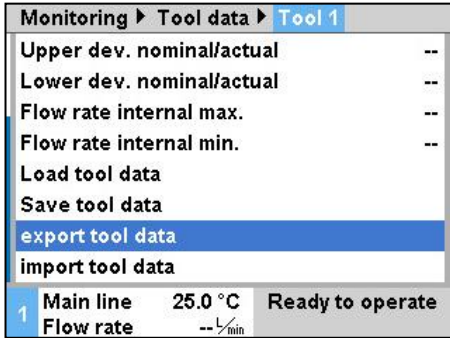

Fig. 70: export tool data

Proceed as follows in order to export the selected tool data set to a USB data carrier:

1. Connect USB data carrier to front connector.
2. Display menu page **Monitoring \ Tool data \ Tool 1..10.**
3. Select the parameter **Export tool data** and confirm with the **OK** key.
4. In the Explorer window, select the directory and confirm with **OK**.

→ The file is saved to the selected directory on the USB data carrier.

**Import tool data**

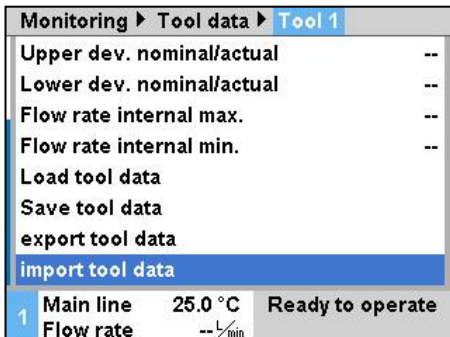

Fig. 71: Import tool data

Proceed as follows in order to import the selected tool data set from a USB data carrier:

1. Connect USB data carrier to front connector.
2. Display menu page **Monitoring \ Tool data \ Tool 1..10.**
3. Select the parameter **Import tool data** and confirm with the **OK** key.
4. In the Explorer window, select the directory and confirm with **OK**.

→ The data will be written to the tool data set in the unit.

**File name**

The following file name is created on the USB data carrier when exporting or can be loaded when importing.

Exa. **E512XB [1].csv**  
                   ↑                  ↑  
                   Index <sup>1</sup>  
                   Tool name entered

<sup>1</sup> An index is automatically added when the file name already exists.

## Operation

### 8.12.2 Recording actual data

#### Function

When the **Record USB** function is activated, the values selected in **Setting \ Recording USB** are written to the USB data carrier.- A new recording file is created each day. If saving to the USB data carrier is not possible, a corresponding warning is displayed.-

#### Start recording

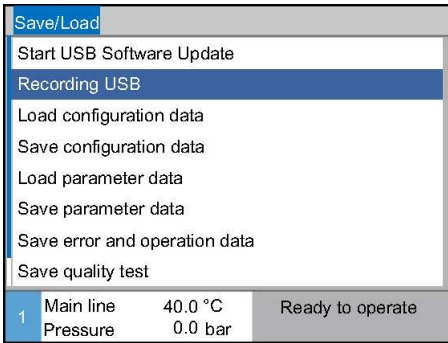



Fig. 72: Recording USB

Proceed as follows to start recording actual data to a USB data carrier:

1. Display menu page **Save/Load**.
2. Connect USB data carrier to front connector.
3. Select the **Recording USB** function and confirm with the  key.

The function activated is indicated with the  symbol.

→ The data is saved to the USB data carrier.

→ The active Recording USB is indicated with the  symbol on the basic display.

#### Stop recording

Proceed as follows to stop an active recording:

1. Display menu page **Save/Load**.
  2. Select the **Recording USB** function and confirm with the  key.
- The USB data carrier can be removed.

#### Set recording interval

Proceed as follows to set the recording interval:

1. Display the menu page **Settings \ Recording USB**
2. Set parameter **Cycle serial recording** to the desired value.



**NOTICE!**

*If the desired recording interval is not possible, recording will be made at the fastest possible interval.*

#### Select values

Proceed as follows to choose the values to be recorded:

1. Display the menu page **Settings \ Recording USB**
2. Select the desired value and confirm with the  key.

The active value is indicated with the  symbol.



**NOTICE!**

*You may choose as many values as you like.*

## Operation

### File name

For each unit, a separate directory is automatically generated on the USB data carrier and the recording files are written in it.-

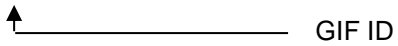
Exa. **HB\_Data\_00001234**  

The unit automatically creates file names on the USB data carrier according to the following examples:

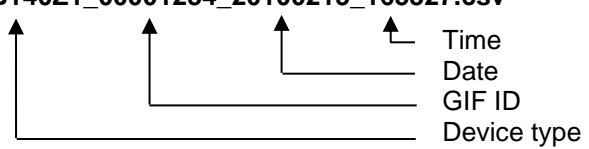
Exa. **HB140Z1\_00001234\_20100215\_165327.csv**  



#### NOTICE!

The GIF-ID can be seen under *Display \ Module*.

### Visualize the data recorded

To visualize and prepare the actual data recorded, the VIP (Visualisation programme – Recording of actual values) software can be downloaded from [www.hb-therm.ch](http://www.hb-therm.ch).

## Maintenance

# 9 Maintenance

## 9.1 Safety

### Personnel

- Maintenance tasks described here can be performed by the operator, unless otherwise indicated.
- Some maintenance tasks must only be carried out by qualified personnel or by the manufacturer exclusively. If this is required, it is pointed out separately in the description of the respective faults.
- As a rule, work on the electrical system must only be carried out by certified electricians.
- Work on the hydraulic system must only be carried out by qualified hydraulics technicians.

### Personal protective equipment

Wear the following protective equipment for all maintenance/repair work:

- Safety goggles
- Protective gloves
- Safety shoes
- Protective clothing



#### NOTE!

*For specific work, the warning notices in this chapter draw special attention to further protective equipment.*

### Special dangers

The following dangers exist:

- Danger of fatal injury by electric current.
- Risk of burns due to hot materials.
- Risk of burns due to hot surfaces.
- Danger of crushing due to rolling away or tipping.

### Maintenance / repair work carried out improperly



#### WARNING!

#### **Danger of injury due to maintenance / repair work carried out improperly!**

Improper maintenance / repair work can lead to severe personal injury or material damage.

Therefore:

- Before starting work, ensure that there is sufficient space for assembly.
- When assemblies are removed, observe correct assembly, re-assemble all fixing elements and observe screw torque specifications.

## 9.2 Open the unit

The unit has to be opened for specific maintenance work.

- Only to be carried out by a specialist or instructed person.
- Necessary tools (depending on unit status):
  - Torx screwdriver.
  - Hexagon or flat-bladed screwdriver.



### **DANGER!**

#### **Danger of death by electric current!**

Live parts are dangerous. Contact with high voltages causes injury or death.

Therefore:

- Work on the electrical system must only be carried out by certified electricians.
- For all work on the electrical system, for maintenance, cleaning or repair work, disconnect from the mains or disconnect all phases of the external power supply and secure them against being switched on again.
- Check unit is isolated from power supply.



### **WARNING!**

#### **Safety risk due to wrongly mounted or missing insulation!**

Wrongly mounted or missing insulation can lead to overheating or total breakdown.

Therefore:

- Remount all insulation correctly.

## Maintenance

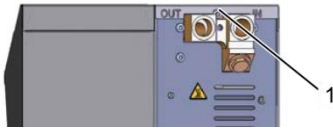

Fig. 73: Loosen screws



Fig. 74: Remove cover plate

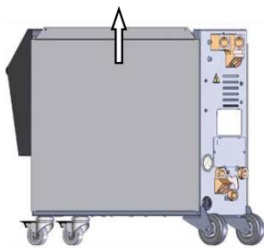

Fig. 75: Pull side plate upwards



Fig. 76: Pull out the side plate

### Access to electrical part

1. Use a screwdriver to loosen and remove the screw in the cover plate.

2. Pull the cover plate approx. 1 cm to the rear and lift off upwards.

3. Pull the side plate slightly upwards.

4. Pull the side plate upwards at a slight angle out of the securing straps and remove it.

Access to the electrical part is obtained by hinging down the front panel.

### 9.3 Maintenance schedule

The next paragraphs describe the maintenance work necessary for optimum and trouble-free operation.

If, during regular checks, increased wear is detected, then the required maintenance intervals are to be reduced corresponding to the actual signs of wear.

For questions concerning maintenance work and intervals, please contact the HB-Therm representative (→ [www.hb-therm.ch](http://www.hb-therm.ch)).

The pump, heating and cooler components are subject to the integrated maintenance interval.

The progress of the upcoming maintenance work is displayed under **Display \ Actual value** in percent. If one of these maintenance intervals reaches 100 %, the symbol  in the standard display will indicate that maintenance is required.

After doing maintenance work, reset the corresponding maintenance interval under **Display \ Actual value** with the  key.

Interval	Assembly / Component	Maintenance work	Carried out by
quarterly or ~1000 h	Cooling water filter	Clean	Operator
	Return line filter	Clean	Operator
	Pump air filter	Clean	Operator
	Front panel filter	Clean	Operator
	Screw connectors	Check for firm seating and damage If necessary tighten or replace	Qualified personnel
half-yearly or ~2000 h	Seals	Check for damage Replace if necessary	Qualified personnel
	Pump	Check for wear (→ page 106) If necessary clean or replace	Qualified personnel
	Heating	Check for blockages and deposits If necessary clean or replace	Qualified personnel
	Valves	Check for contamination If necessary clean or replace	Qualified personnel
	Cooler	Check for blockages and deposits If necessary clean or replace	Qualified personnel
	Safety valve	Check function (→ page 108) If necessary clean or replace	Qualified personnel

## Maintenance

Interval	Assembly / Component	Maintenance work	Carried out by
Every 1½ years or ~6000 h	Hydraulic hose lines (internal) <sup>1)</sup>	Check for damage on outer sheath and in the sealing area	Hydraulic specialist
		Replace if necessary	Hydraulic specialist
	Temperature limiter main line	Check fixing	Certified electrician
		Tighten if necessary	Certified electrician
	Electrical wiring	Check electrical wiring for damage to outer sheath	Certified electrician
		Replace if necessary	Certified electrician
	Temperature measurement	Check accuracy of temperature measurement (→ page 107)	Qualified personnel
	Pressure measurement	Check accuracy of pressure measurement (→ page 108)	Qualified personnel

1) The maintenance of external hoses is to be carried out according to the manufacturer's instructions.



## 9.4 Maintenance tasks

### 9.4.1 Cleaning

**CAUTION!****Risk of burns due to hot surfaces!**

Contact with hot parts can cause burns.

Therefore:

- Wait for the unit to cool down, depressurise it and switch it off.
- Before carrying out any work, ensure that all parts have cooled down to ambient temperature.

Clean the unit under the following conditions:

- Only clean the outer parts of the unit with a soft, moist cloth.
- Do not use any aggressive cleaning agents.

## Maintenance

### 9.4.2 Pump

Check the pump

- Only to be carried out by a specialist



#### **DANGER!**

#### **Danger of fatal injury from magnetic field!**

The strong magnetic field in the vicinity of the magnetic drive pump can be life-threatening for people with pacemakers.

Therefore:

- Ensure that people with pacemakers do not carry out any maintenance work which would result in dismantling the magnetic coupling (replacing the pump head, replacing the seal on the containment can).



#### **NOTICE!**

*When pumps are fully assembled, the magnetic fields are shielded completely by the components which surround them and there is no danger, either when the pump is idling or in operation.*

#### **Necessary equipment**

- Test control unit for quality control (condition of the pump), further information under [www.hb-therm.ch](http://www.hb-therm.ch).



#### **NOTICE!**

*No test control unit is required if there is a built-in pump wear monitor (ZU).*

#### **Impeller**

- Checking the condition of the pump → page 91
- If there is no built-in pump wear monitor  
→ use the test control unit for quality control.

#### **Seals**

- Carry out a visual inspection of the pump for impermeability.

#### **Engine mount**

- Idling: Check free movement of the mount
- In operation: Check engine noise

### 9.4.3 Temperature measurement

Check the accuracy of the temperature measurement

- Only to be carried out by a specialist.

#### Necessary equipment

- Main and return line connecting hoses with built-in temperature sensor (minimum inner diameter 8 mm, maximum length 1 m)
- Fully tested temperature measuring instrument released for the reference measurement (calibrated to the temperature sensor used).
- Test protocol to document the measured values
- Optionally, test equipment can be used for the temperature measurement. Further information under [www.hb-therm.ch](http://www.hb-therm.ch)

#### Procedure for temperature measurement internal temperature sensor

1. Connect main and return line connecting hoses between the main and return line connections.
2. Switch on temperature control unit.
3. Set nominal value to 80 °C.
4. Wait until the required temperature has been reached and remains constant.
5. Read off the main and return line temperature displayed on the unit and compare with the temperature indicated on the reference measuring instrument.

#### Procedure for temperature measurement external temperature sensor

1. Connect external temperature sensor to unit.
2. Hold the external temperature sensor in a temperature reference bath at 80 °C.
3. Switch on temperature control unit.
4. Read off the external temperature displayed on the unit and compare with the reference bath temperature.

#### Calibrate temperature sensor

- With a deviation of <math><3\text{ °C}</math>, the temperature measurement lies within the tolerance range.
- With a deviation of >math>>3\text{ °C}</math>, the temperature sensor in the unit must be checked. With larger linear errors, the individual temperature sensors can be calibrated on menu page [Service \ Calibration \ Temperature](#).

If you have any questions, please contact your nearest HB-Therm - representative (→ [www.hb-therm.ch](http://www.hb-therm.ch)).

## Maintenance

### 9.4.4 Pressure measurement

Check the accuracy of the pressure measurement

- Only to be carried out by a specialist.

#### Necessary equipment

- no special equipment
- Optionally, test equipment can be used for the pressure measurement. Further information under [www.hb-therm.ch](http://www.hb-therm.ch)

#### Procedure

1. Switch off the temperature control unit by means of mould evacuation.
  2. Uncouple consumers on main and return lines.
  3. Manometer pressure indicator must indicate 0 bar +0.3 bar.
  4. **System pressure actual value** on menu page **Display \ Actual value** must indicate 0.0 bar  $\pm 0.1$  bar.
- With a deviation of  $>0.1$  bar, the pressure sensor must be calibrated. On menu page **Service \ Calibration \ Pressure**, calibrate parameter **Pressure sensor 1 offset**.

#### Additional procedure (additional equipment ZU)

5. **Main line pressure** on menu page **Display \ Actual value** must indicate 0.0 bar  $\pm 0.1$  bar.
- With a deviation of  $>0.1$  bar, the pressure sensor must be calibrated. On menu page **Service \ Calibration \ Pressure**, calibrate parameter **Pressure sensor 2 offset**.

### 9.4.5 Safety valve

Check the function of the safety valve

- Only to be carried out by a specialist.

#### Procedure

1. Remote the unit covers.
  2. Switch on temperature control unit (normal operation).
  3. Set nominal value to 40 °C.
  4. Open the knurled nut on the safety valve until a little water escapes via the overflow.
- If no water escapes through the safety valve, then correct functioning is no longer guaranteed and the safety valve must be replaced.
5. Re-close the knurled nut on the safety valve.
- If the safety valve closes correctly again, then functioning is OK.

## 9.4.6 Software update

Proceed as follows in order to install a new user programme on an individual unit:



**NOTICE!**

*For single units that are operated as a module (→ page 67) for software version SW51-2\_1452 only GIF-51 is updated. From software version SW51-2\_1452, USR-51 is updated additionally.*



**NOTICE!**

*The "gba03Usr.upd", "SW51-1\_xxxx.upd" or "SW51-2\_xxxx.upd" software must be in the root of the data carrier. It may not be stored in a folder.*



**NOTICE!**

*During the software update, the Thermo-5 unit or the Panel-5 control model and all products connected to them may not be switched off.*

**Necessary tools:**

- USB data carrier with the current software
- The latest software can be acquired from the HB-Therm representative (→ [www.hb-therm.ch](http://www.hb-therm.ch)).



**NOTICE!**

*Only USB data carriers in FAT32 format are supported.*

## Maintenance

### Run software update

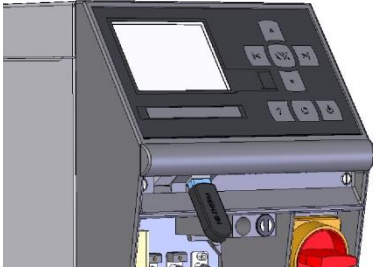

Fig. 77: Connect USB data carrier

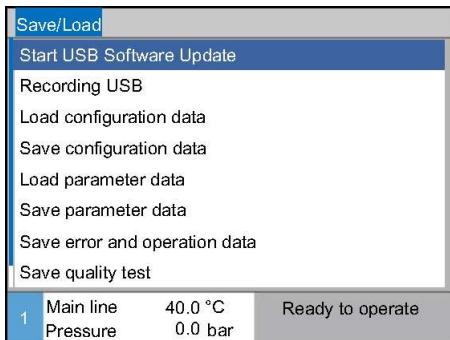

Fig. 78: Start USB software update

### Checking the software version

1. Switch on main switch.
  2. Connect USB data carrier (Fig. 77).
  3. Display menu page **Profile**.
  4. Set parameter **User profile** to "Enhanced".
  5. Display menu page **Save/Load**.
  6. Select function **Start USB Software Update** and confirm with the **OK** key.
    - The data is loaded from the USB data carrier to the memory in the USR-51. Do not disconnect the USB connection.
    - Conclusion of data transfer is indicated on the display. The USB connection can now be disconnected.
    - The new software is written to the USR-51 flash. On completion, an automatic restart is initiated.
  7. If required, the USB connection must be re-established to install further data.
    - If necessary, the new software is written to the connected GIF-51, DFM-51 or VFC-51 after the restart. This process can take a few minutes. On completion, another restart takes place.
    - The message *Ready to operate* appears on the display.
- 
1. In the basic display, press the **?** key.
    - The current software version appears at the top right.

### 9.4.7 Gain access to components

To gain access to components and to replace these, if necessary, the unit must first be opened (→ page 101).

#### Cooling valve 1

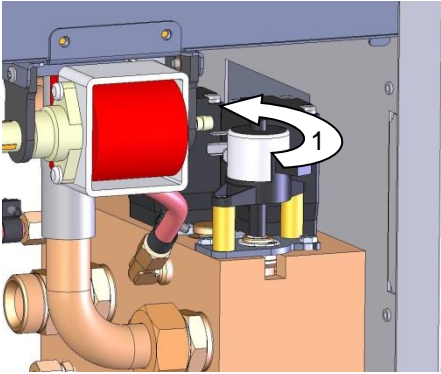

Fig. 79: Remove cooling valve 1

1. Completely empty the temperature control unit.
2. Loosen the flange screws on the drive.
3. Turn the drive slightly (1) and move out.
4. Remove cooling valve 1.

#### Cooling valve 2

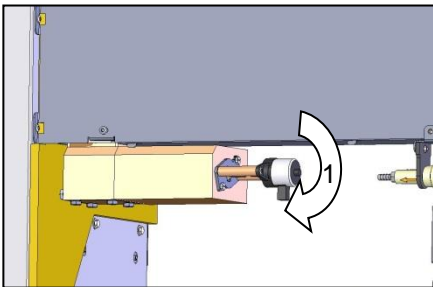

Fig. 80: Cooling valve 2

1. Completely empty the temperature control unit.
2. Loosen the flange screws on the drive.
3. Turn the drive slightly (1) and move out.
4. Remove cooling valve 2.

#### Valves

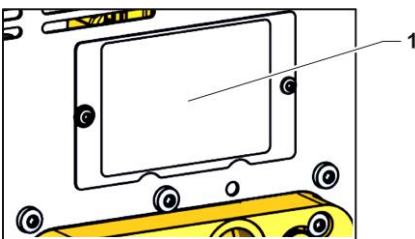

Fig. 81: Valve cover

1. Completely empty the temperature control unit.
2. Unscrew and remove the fixing screws for the cover plate (1) on the lower rear panel.

## Maintenance

### Heating element

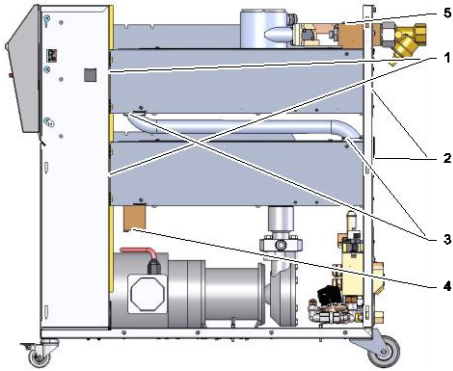

Fig. 82: Removing the heating element

1. Completely empty the temperature control unit.
2. Remove the fixing screws (4) and remove the brass block.
3. Remove the fixing screws (3) and remove the pipe.
4. Remove fixing screws (5)
5. Remove fixing screws (2) of the heating element at the rear wall.
6. Remove fixing screws (1) of the heating element to the control box.
7. Swivel the front heating element outwards and remove the heater.

### Unit board

1. Disconnect the mains plug from the mains supply.
2. Loosen the screws in the front panel.
3. Hinge down the front panel.



## 10 Faults

The following chapter describes possible causes of malfunctions and what to do to remove them.

In the case of increased disturbances, reduce the maintenance intervals according to the actual burden.

In the case of faults, which can not be remedied by the following instructions, contact the HB-Therm representative (→ [www.hb-therm.ch](http://www.hb-therm.ch)). For error diagnoses, service information can be saved to a USB data carrier and sent to the HB-Therm representative (→ page 94).

### 10.1 Safety

#### Personnel

- Tasks for troubleshooting described here can be performed by the operator, unless otherwise indicated.
- Some tasks must only be carried out by qualified personnel or by the manufacturer exclusively. If this is required, it is pointed out separately in the description of the respective faults.
- As a rule, work on the electrical system must only be carried out by certified electricians.
- Work on the hydraulic system must only be carried out by qualified hydraulics technicians.

#### Personal protective equipment

Wear the following protective equipment for all maintenance/repair work:

- Safety goggles
- Protective gloves
- Safety shoes
- Protective clothing



#### **NOTE!**

*For specific work, the warning notices in this chapter draw special attention to further protective equipment.*

#### Special dangers

The following dangers exist:

- Danger of fatal injury by electric current.
- Risk of burns due to hot materials.
- Risk of burns due to hot surfaces.
- Danger of crushing due to rolling away or tipping.

## Faults

### Maintenance / repair work carried out improperly



#### **WARNING!**

#### **Danger of injury due to maintenance / repair work carried out improperly!**

Improper maintenance / repair work can lead to severe personal injury or material damage.

Therefore:

- Before starting work, ensure that there is sufficient space for assembly.
- When assemblies are removed, observe correct assembly, re-assemble all fixing elements and observe screw torque specifications.

### In case of faults:

The following general rules apply:

1. In the event of faults that pose immediate danger to man or machine, activate the emergency shutoff function immediately.
2. Determine cause of fault.
3. If elimination of the fault requires working in the danger zone, switch off unit and secure against being switched on again.
4. Immediately inform the person in charge at the equipment location of the fault.
5. Depending on the type of fault, eliminate the fault or have it eliminated by an authorized specialist.



#### **NOTE!**

*The chapter "Troubleshooting" below provides information on who is authorised to eliminate the fault.*

## 10.2 Fault indications

### 10.2.1 Fault indication display

A differentiation is made between four alarm levels that are indicated; on the display in the status bar according to the following table:

Level	Characteristic	Display	Heating element	Pump	Cooling	Acknowledgement	Alarm output
0	Limit values have been exceeded. The transgression has an influence on the heating system of the unit.	yellow	off	-	-	not compulsory	-
1	Limit values have been exceeded. The transgression has no influence on the operational safety of the unit.	yellow	-	-	-	not compulsory	Horn Alarm contact Interface
2	Limit values have been exceeded. The transgression has an influence on the heating system of the unit.	red	off	-	-	compulsory	Horn Alarm contact Interface
3	Limit values have been exceeded. The transgression has a direct influence on the operational safety of the unit.	red	off	off	off	compulsory	Horn Alarm contact Interface

On faults of alarm levels 1 - 3:

→ Horn, alarm contact (additional equipment ZB) are activated and the alarm is transmitted to the interface (additional equipment ZD, ZC, ZP).

→   →  is displayed in the symbol field.

1. Acknowledge horn with the  key.

→   →  is displayed in the symbol field .

2. Determine the cause of a fault. If required, contact the HB-Therm representative (→ [www.hb-therm.ch](http://www.hb-therm.ch)).

3. Acknowledge alarm with the  key

## Faults

### 10.3 Determine the cause of a fault

#### Cause of a fault

Proceed as follows to identify the possible causes for a current fault indication:

1. Press the  key to display the online help for the pending fault indication.

#### Fault overview

Fault finding			
06.02.14 11:53	Emptying time exceeded		
S	GIF01 Normal operation	E048	26 h
06.02.14 11:53	Undercurrent heating		
S	GIF01 Normal operation	E013	26 h
1	Main line Pressure	37.1 °C 1.5 bar	Ready to operate

You can display the last 10 fault indications that occurred as follows:

1. Open the **Fault finding** menu page.
  - The fault indications overview is displayed. Fault indications marked with "S" occurred during the start-up phase of the temperature control unit.
2. Select desired fault indication.
3. Press the  key.
  - The online help is displayed for the selected fault indication.

Fig. 83: Logbook Alarms

## Faults

### 10.4 Troubleshooting chart

Fault	Possible cause	Rectification	Rectified by
Undercurrent heater or Overcurrent heater	Not connected to the correct mains voltage	Connect to the correct mains voltage	Certified electrician
	Plug connections not correctly connected or broken	Check plug connections Where applicable, connect properly or replace	Certified electrician
	Semiconductor relay defective	Replace semiconductor relay	Certified electrician
	Heater defective	Repair or replace heater	Certified electrician
Undercurrent pump or Overcurrent pump	Not connected to the correct mains voltage	Connect to the correct mains voltage	Certified electrician
	Pump defective	Repair or replace pump	Qualified personnel
	Motor overload switch triggered	Set motor overload switch correctly in accordance with table (→ page 122)	Certified electrician
Phase missing	Mains connection not made correctly	Make mains connection properly	Certified electrician
Overtemperature circuit	Cooling water connection not made correctly	Make the cooling water connection properly	Qualified personnel
	Cooling valve 1 or cooling valve 2 defective	Check cooling valve 1 or cooling valve 2, replace if necessary	Qualified personnel
	Temperature sensor not calibrated properly	Calibrate temperature sensor	Qualified personnel
	Temperature sensor defective	Replace temperature sensor	Qualified personnel

## Faults

Fault	Possible cause	Rectification	Rectified by
System pressure too low or Initial filling time exceeded or Filling time exceeded	Large external volume	Acknowledge alarm (for initial filling time exceeded).	Operator
	Mains water pressure too low.	Increase mains water pressure.	Operator
	Cooling water or system water connection not made correctly	Make cooling water or system water connection properly (open cut-off valves where available)	Operator
	Quick-release connectors used are closed or blocked	Check quick-release connectors, clean or replace as necessary	Qualified personnel
	Hose connections defective	Check hose connections for leaks, replace as necessary	Operator
	Filling pump defective	Repair or replace filling pump	Qualified personnel
	Pressure sensor not calibrated properly	Calibrate pressure sensor	Qualified personnel
	Pressure sensor defective	Replace pressure sensor	Qualified personnel
Filling cycle exceeded	Hose connections defective	Check hose connections for leaks, replace as necessary	Operator
No flow rate available or Flow rate too low	Filter in main or return line contaminated.	Clean filter in main or return line.	Qualified personnel
	Parameter Flow rate internal min. set too low.	Increase Flow rate internal min. (when flow rate too low).	Operator
	Quick-release connectors used are closed or blocked.	Check quick-release connectors, clean or replace as necessary.	Qualified personnel
	Hose connections kinked.	Rectify kinks in hose connections.	Operator
	Consumer blocked.	Check consumer, clean as necessary.	Qualified personnel

## Faults

Fault	Possible cause	Rectification	Rectified by
Upper temperature deviation	Cooling water or system water connection not made correctly	Make cooling water or system water connection properly	Operator
	Parameter Upper dev. nominal/actual set too low	Increase parameter Upper dev. nominal/actual	Operator
	Regulation parameter not optimally set	Optimise regulation parameter	Qualified personnel
Lower temperature deviation	Parameter Lower dev. nominal/actual set too low	Increase parameter Lower dev. nominal/actual	Operator
	Regulation parameter not optimally set	Optimise regulation parameter	Qualified personnel
	Cooling valve 1 or cooling valve 2 defective	Check cooling valve 1 or cooling valve 2, replace if necessary	Qualified personnel
	Heating capacity insufficient	Check required heating capacity	Qualified personnel
		Check heater, replace if necessary	

### 10.5 Startup after eliminating fault

After remedying the fault, the following steps should be taken to re-start the system:

1. Reset the Emergency Off devices.
2. Acknowledge the fault at the control unit.
3. Ensure that no one is in the danger zone.
4. Start up in accordance with the instructions in the "Operating" chapter.

## Disposal

# 11 Disposal

## 11.1 Safety

### Personnel

- Disposal must only be carried out by qualified personnel.
- Work on the electrical system must only be carried out by certified electricians.
- Work on the hydraulic system must only be carried out by qualified hydraulics technicians.

## 11.2 Disposal of materials

Once the end of the useful life has been reached, the unit must be disposed of in an environmentally compatible manner.

As long as no return or disposal agreement was made, dismantled constituent parts are to be recycled:

- Metals should be scrapped.
- Plastic elements should be passed on for recycling.
- Other materials should be sorted and disposed of according to material composition.



### **ATTENTION!**

#### **Environmental pollution on wrong disposal!**

Electrical waste, electronic components, grease and other additives are subject to the treatment of special refuse and may only be disposed of by approved specialised companies.

The local authority or specialised disposal companies can give information on environmentally compatible disposal.



## 12 Spare parts

**WARNING!****Safety risk due to wrong spare parts!**

Wrong or defective spare parts can impair safety as well as leading to damage, malfunctions or total breakdown.

Therefore:

- Only use original spare parts from the manufacturer.

Purchase spare parts through the HB-Therm representative (→ [www.hb-therm.ch](http://www.hb-therm.ch)).

The spare parts list can be found in Appendix B of this operating manual.

On use of non-approved spare parts, any guarantee or service claims are forfeited.

### 12.1 Ordering spare parts

When ordering spare parts, always indicate:

- The designation and ID No. of the spare part.
- Amount and unit.

**Technical information**

# 13 Technical information

## 13.1 Electrical circuit diagram

Electrical connection

see nameplate on unit or on page 26.

380–480 V

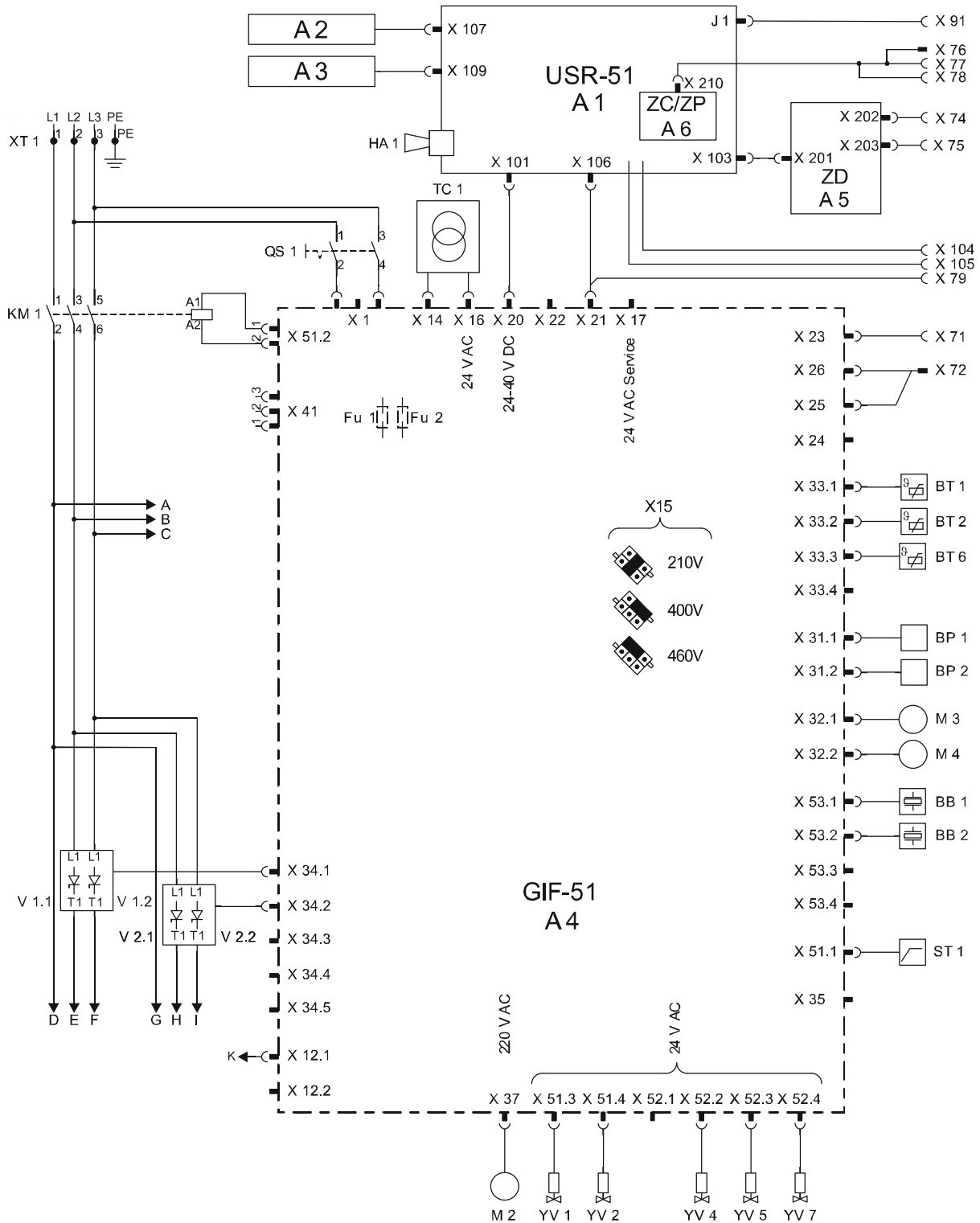

Technical information

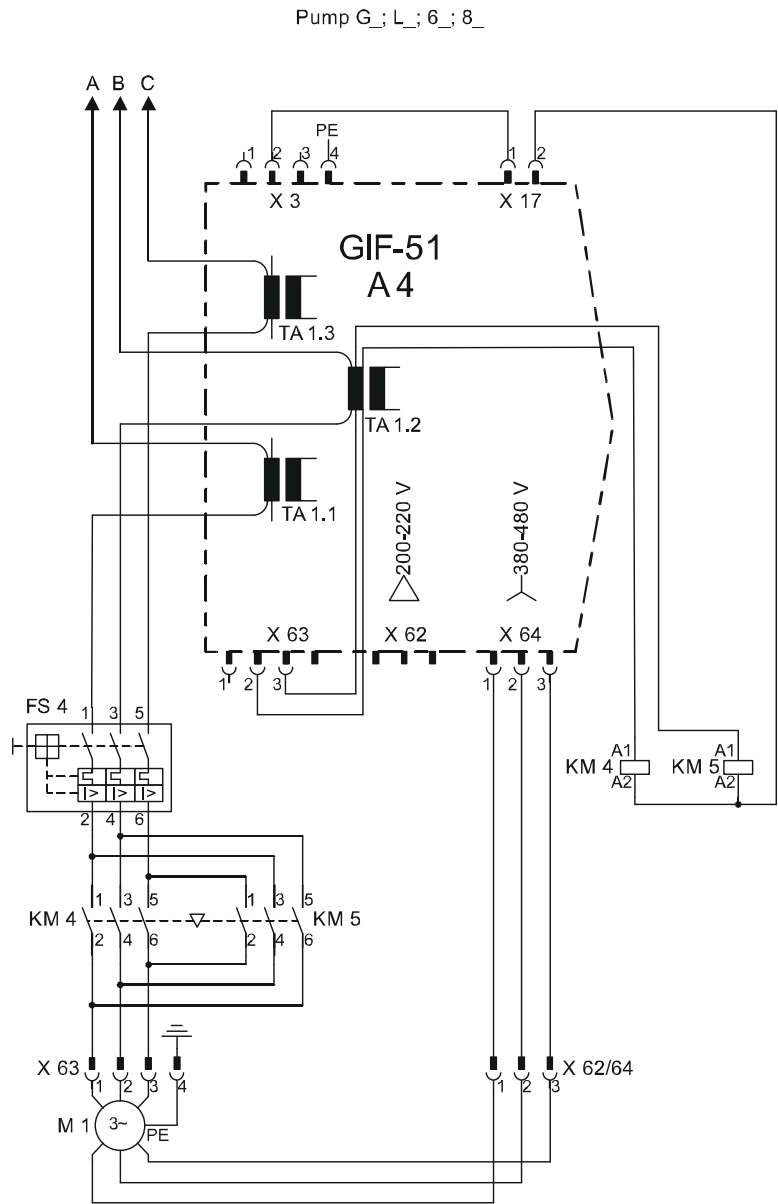
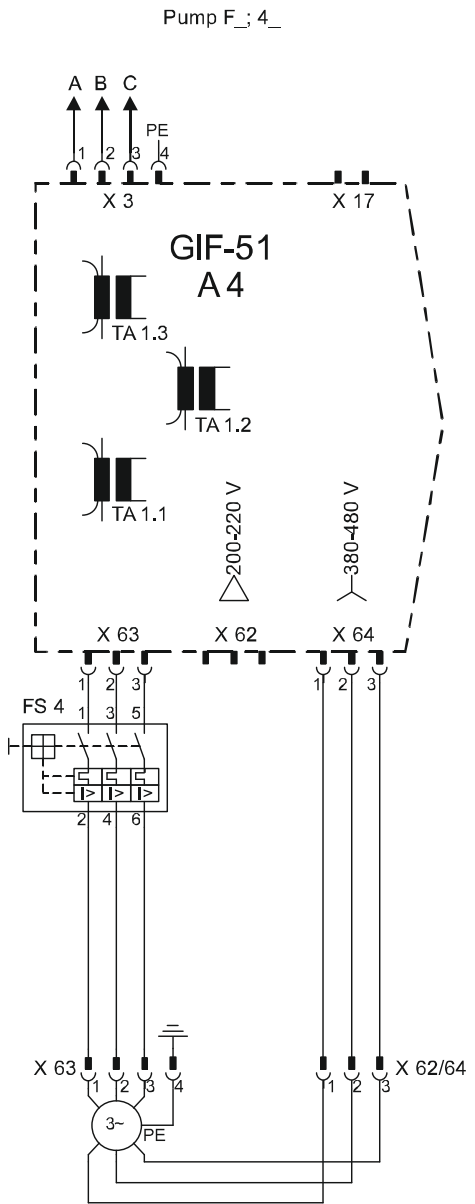

# Technical information

8 kW

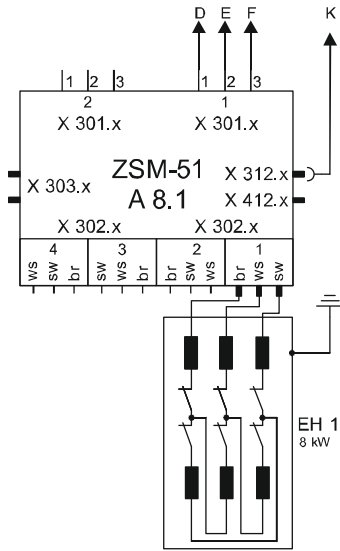

16 kW

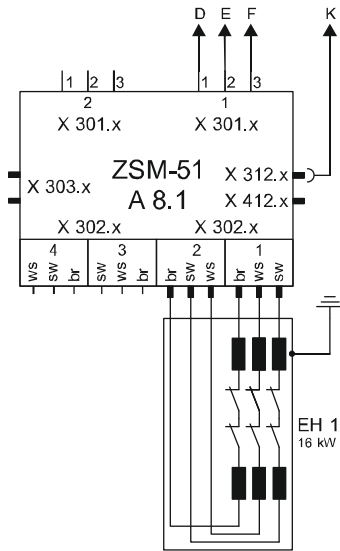

32 kW

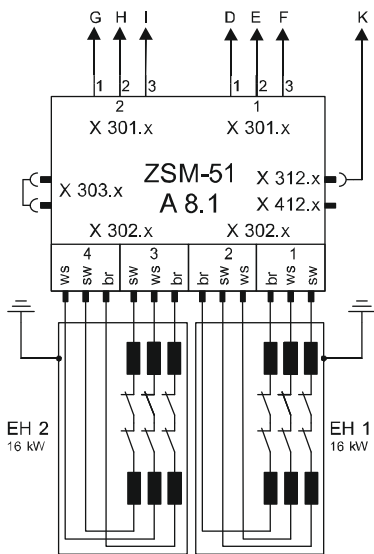

sw = black  
br = brown  
ws = white

Technical information

200–220 V

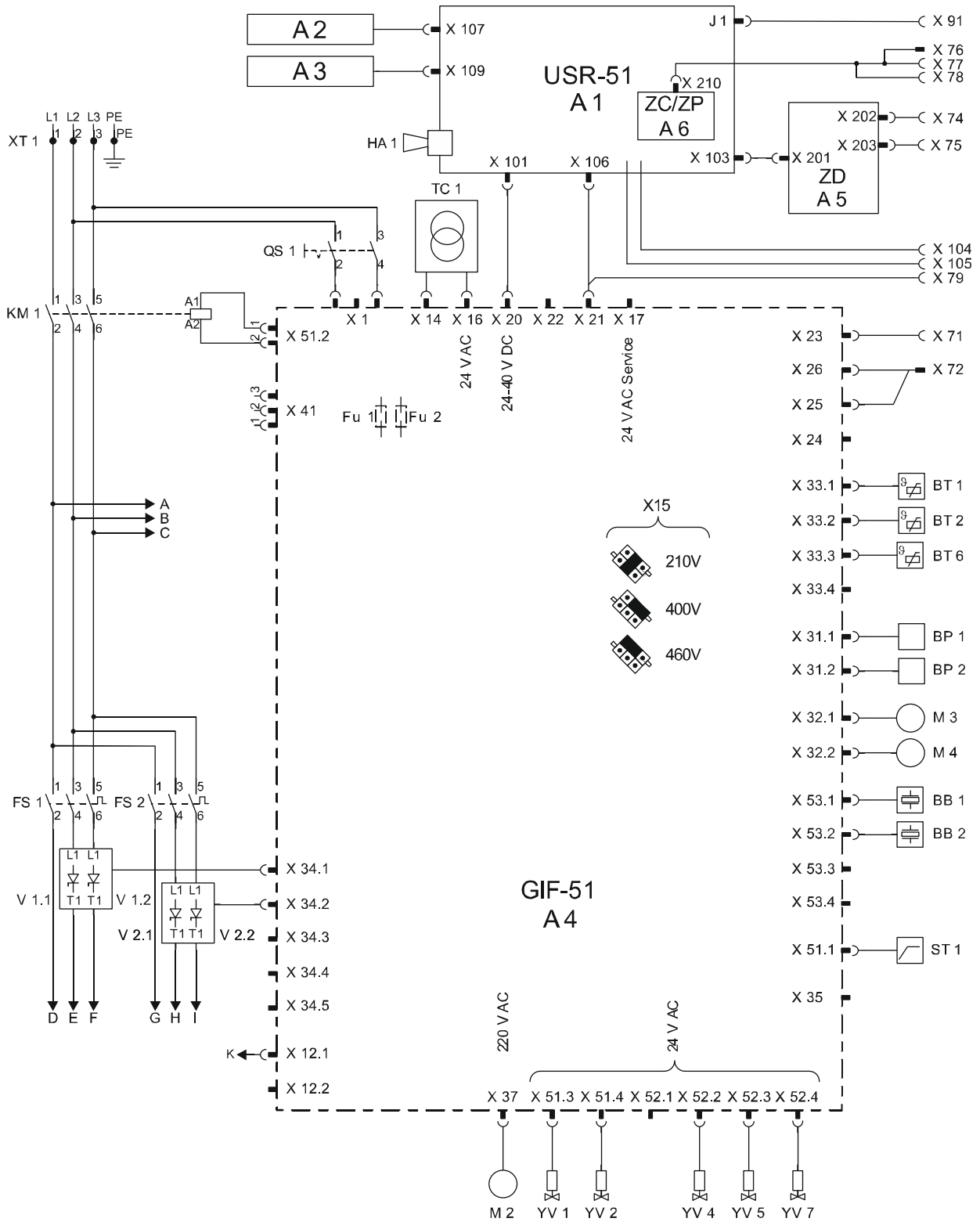

Technical information

Pump F; 4\_

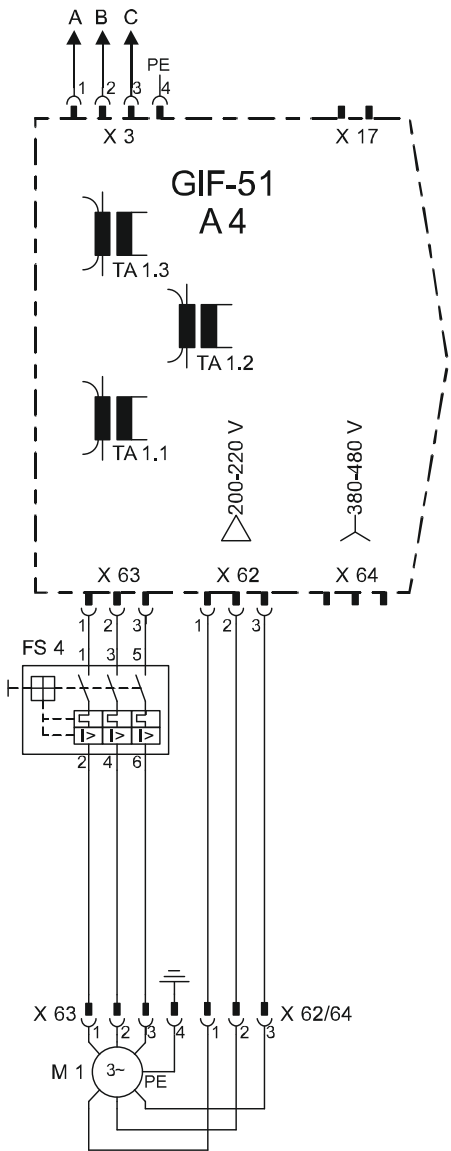

Pump G; L; 6; 8\_

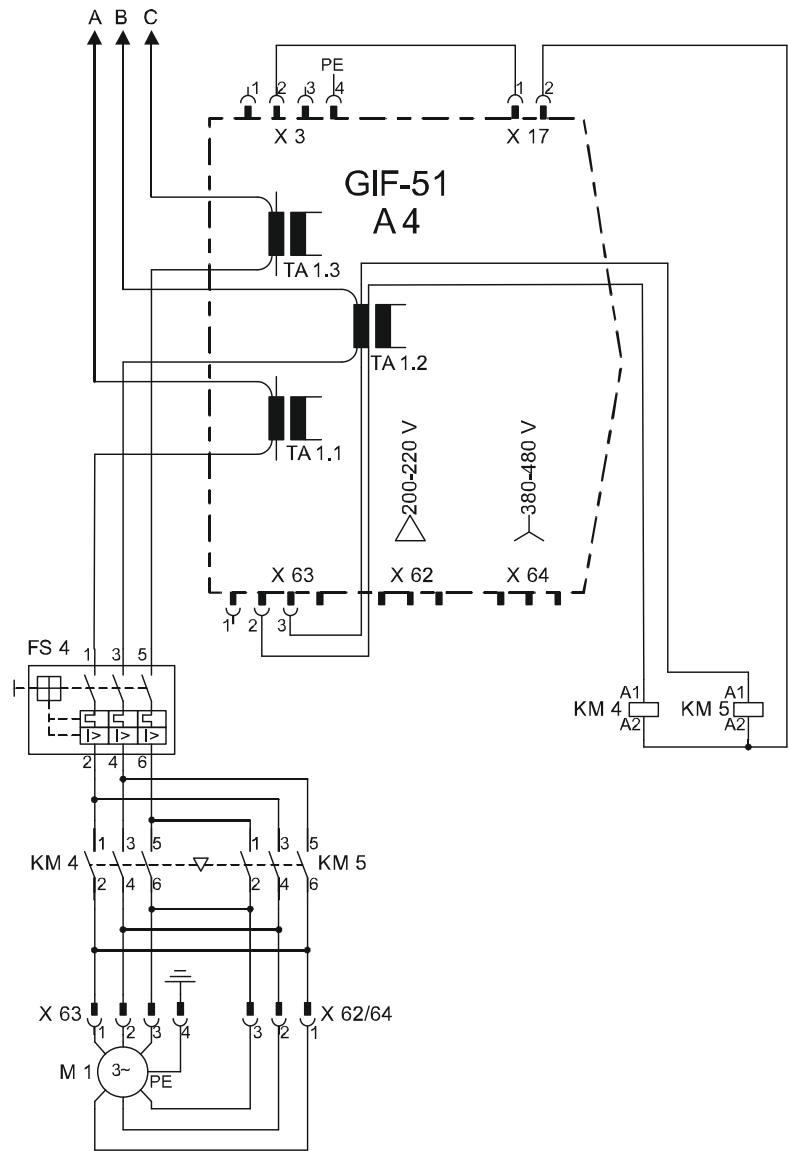

**Technical information**

8 kW

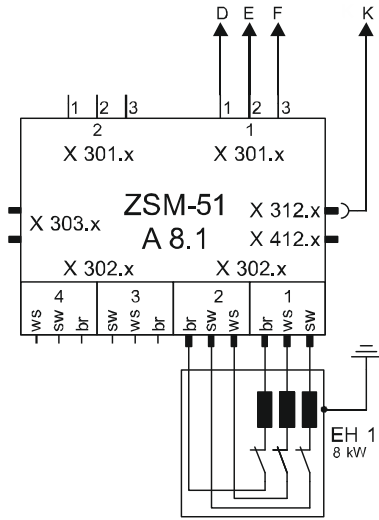

16 kW

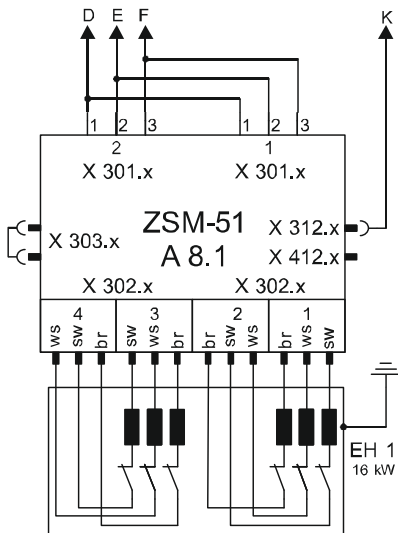

32 kW

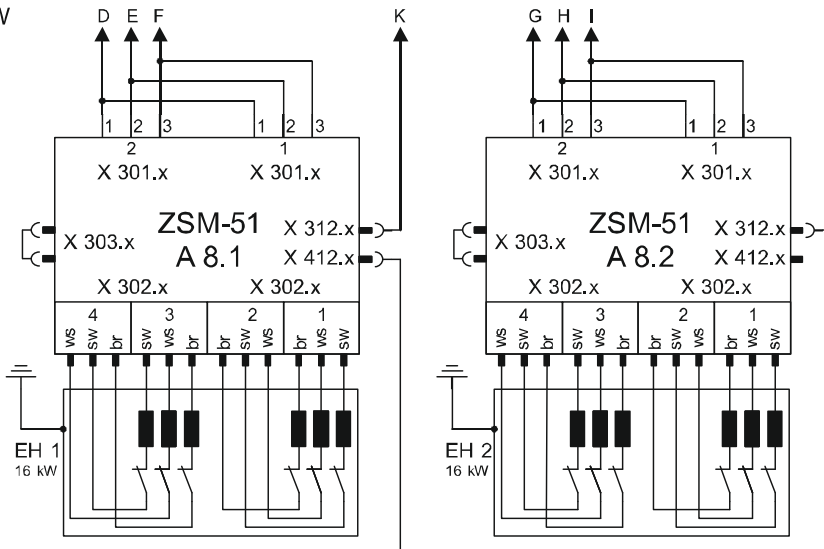

sw = black  
br = brown  
ws = white

**Technical information**

**13.2 Hydraulic scheme**

**HB-100Z3**

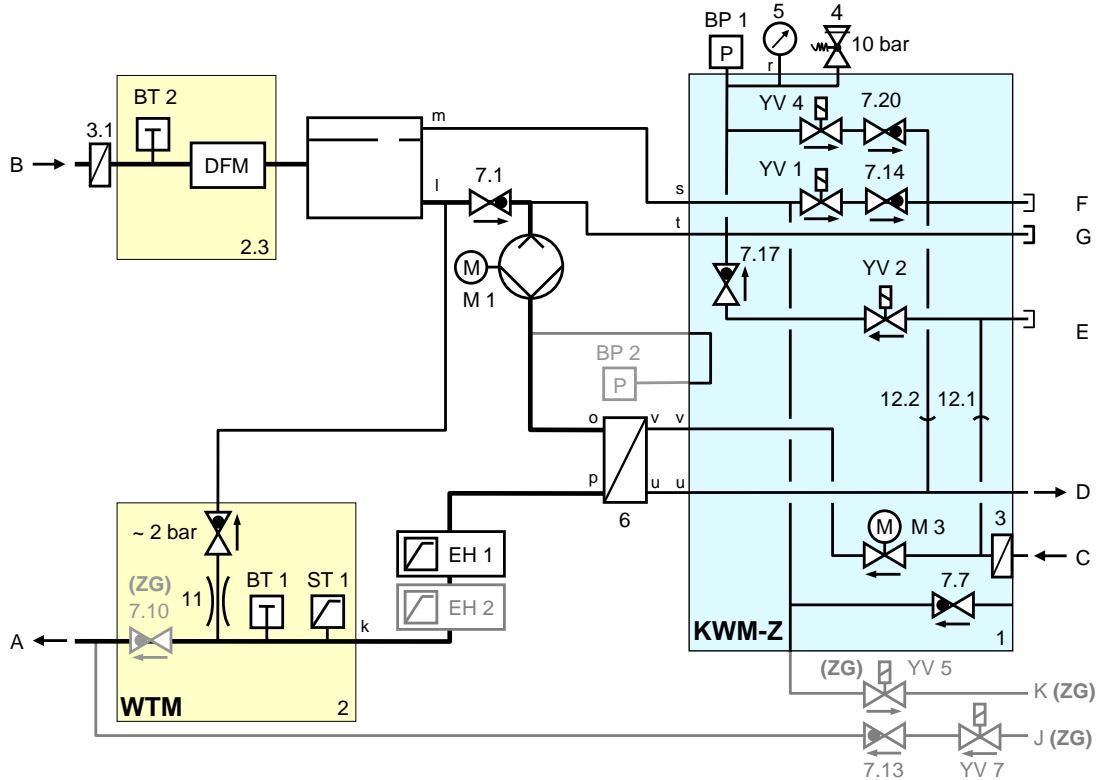

**HB-140/160/180Z3**

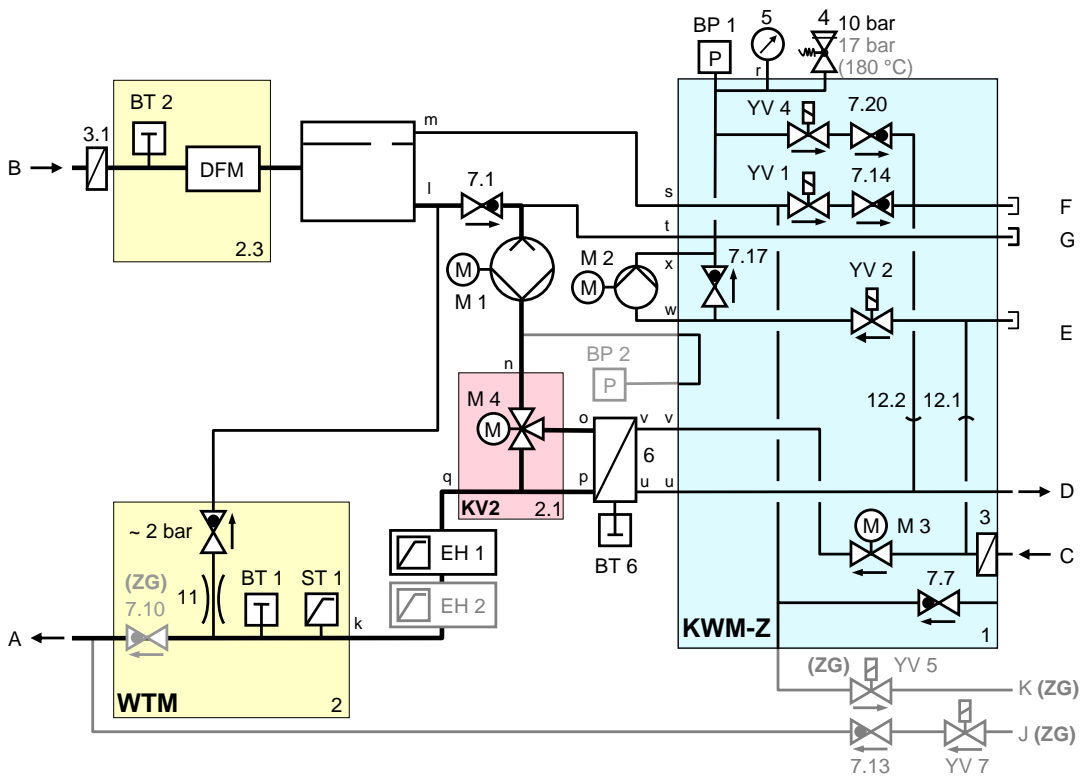



**Technical information**

**13.3 Item location**

**Side view left**

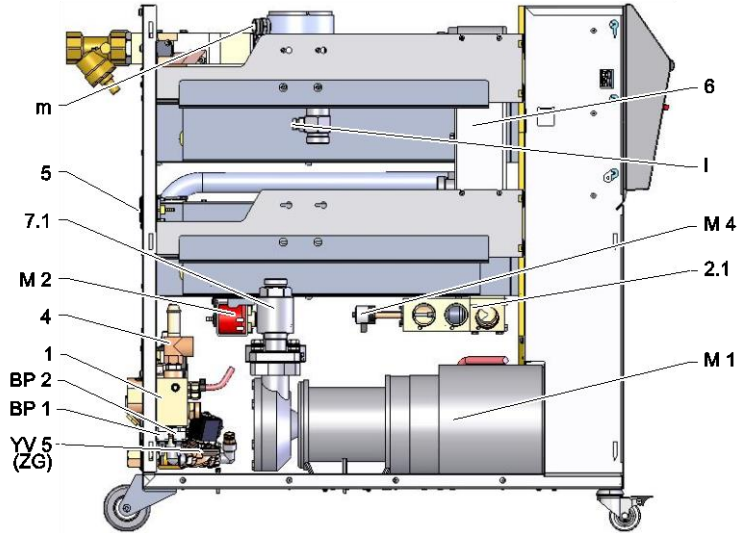

**Side view right**

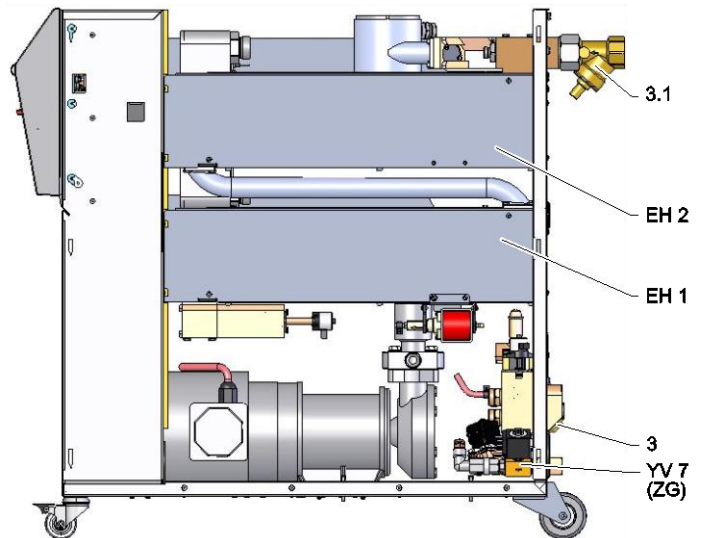

**Cooling water module**

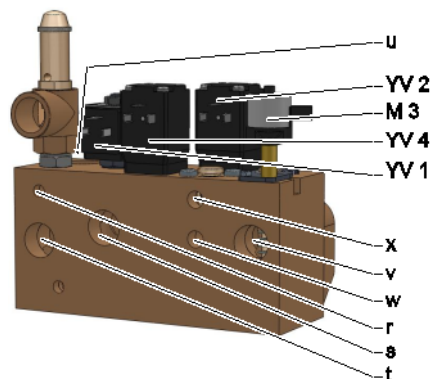

## Technical information

### Heat transfer medium module main line

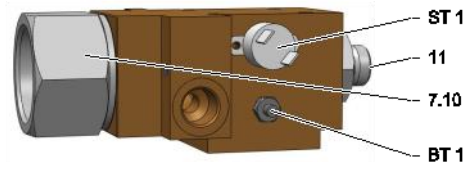

### Heat transfer medium module return line

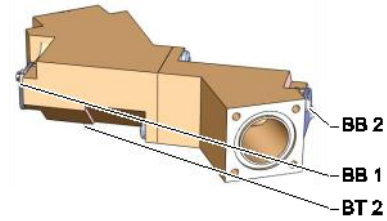

### Proportional module

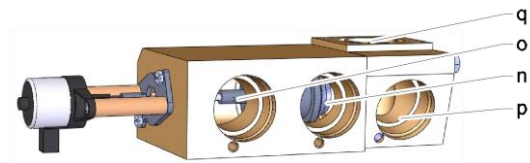

### Cooling

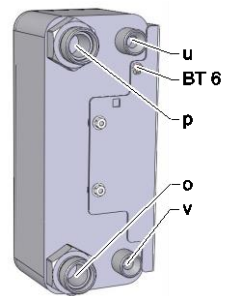

**Technical information**

**Electric components**

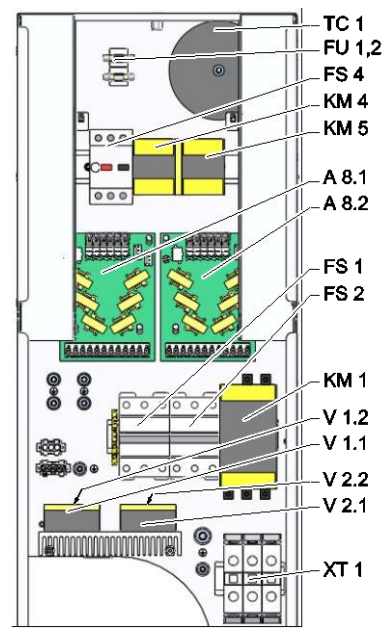

**Front**

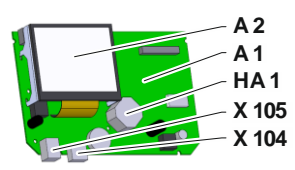
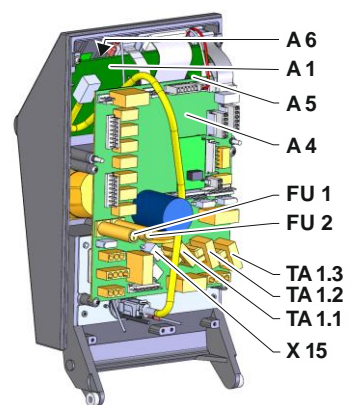
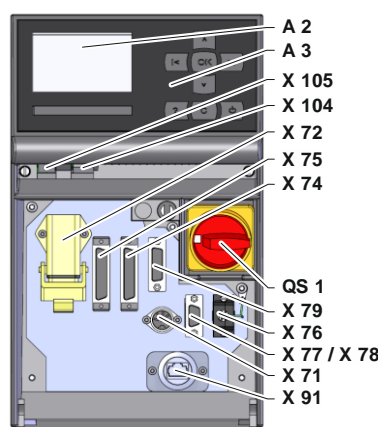

## Technical information

### 13.4 Legend

KZ	Designation	only with version
A	Main line	
B	Return line	
C	Cooling water inlet	
D	Cooling water outlet	
E	System water inlet	
F	System water outlet	
G	Drain	
J	Compressed air inlet	ZG
K	Compressed air outlet	ZG
1	Cooling water module KWM	
2	Heat transfer medium module main line	
2.1	Proportional module KV2	
2.3	Heat transfer medium module return line	
3	Filter cooling water inlet	
3.1	Filter return line	
4	Safety valve	
5	Pressure gauge	
6	Cooling	
7.1	Non return valve return line	
7.7	Non return valve ventilation	
7.10	Non return valve main line	ZG
7.13	Non return valve compressed air	ZG
7.14	Non return valve air relief	
7.17	Non return valve filling	140, 160, 180, 200, 230, ZL
7.20	Non return valve mould evacuation	
11	Bypass with check valve 2 bar	
12.1	Separating cooling and system water inlet	
12.2	Separating cooling and system water outlet	
A 1	Control unit USR-51	
A 2	Display	
A 3	Keyboard	
A 4	Unit board GIF-51	
A 5	DIGITAL module	ZD
A 6	CAN- resp. PROFIBUS-DP- module	ZC, ZP
A 8.1	Current measuring board ZSM	
A 8.2	Current measuring board ZSM	220-220 V, 32 kW
BB 1	Sonic transducer 1	
BB 2	Sonic transducer 2	
BP 1	Pressure sensor system	
BP 2	Pressure sensor main line	ZU, 4S, 8R
BT 1	Heat sensor main line	
BT 2	Temperature sensor return line	
BT 6	Temperature sensor cooling	
EH 1	Heater 1	
EH 2	Heater 2	32 kW

## Technical information

KZ	Designation	only with version
FS 1	Circuit breaker 50 A	200-220 V
FS 2	Circuit breaker 50 A	200-220 V, 32 kW
FS 4	Motor circuit breaker	
FU 1	Fuse 0,8 AT	
FU 2	Fuse 0,8 AT	
HA 1	Horn	
KM 1	Main contactor	
KM 4	Contacteur pump forward	G_, L_, 6_, 8_
KM 5	Contacteur pump reverse	G_, L_, 6_, 8_
M 1	Main pump	
M 2	Filling pump	
M 3	Cooling valve 1 (KV 1)	
M 4	Cooling valve 2 (KV 2)	
N	Mains connection cable	
QS 1	Main switch	
ST 1	Temperature limiter main line	
TA 1.1	Current transformer 1	
TA 1.2	Current transformer 2	
TA 1.3	Current transformer 3	
TC 1	Transformer	
V 1.1	Semiconductor relay heater 1	
V 1.2	Semiconductor relay heater 1	
V 2.1	Semiconductor relay heater 2	32 kW
V 2.2	Semiconductor relay heater 2	32 kW
X 15	Preselection of voltage	
X 71	Socket external sensor	ZE
X 72	Connector alarm contact, external control	ZB
X 74	Connector interface DIGITAL 1	ZD
X 75	Connector interface DIGITAL 2	ZD
X 76	Connector (CAN-Bus)	ZC
X 77	Connector (CAN-Bus)	ZC
X 78	Connector PROFIBUS-DP	ZP
X 79	Socket HB OUT	
X 91	OPC UA socket	ZO
X 104	Connector USB-Host	
X 105	Connector USB-Device	
XT 1	Mains terminal	
YV 1	Solenoid valve air relief	
YV 2	Solenoid valve filling	
YV 4	Solenoid valve mould evacuation	
YV 5	Solenoid valve pressure release	ZG
YV 7	Solenoid valve compressed air	ZG

## Interface cables

### 14 Interface cables

#### 14.1 External sensor

Sensor type thermocouple (type J, K, T)

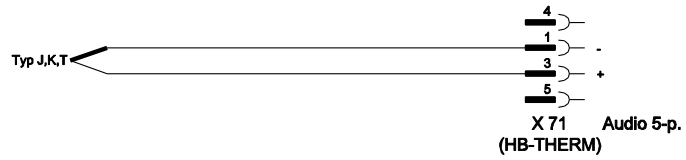

Sensor type Pt 100 (2-wire design)

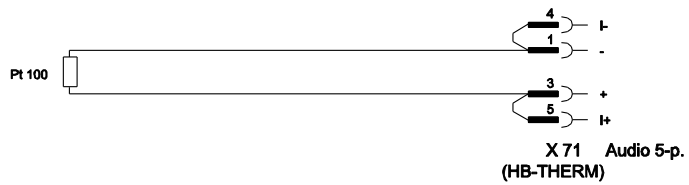

Sensor type Pt 100 (3-wire design)

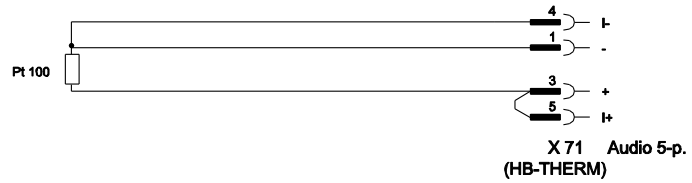

Sensor type Pt 100 (4-wire design)

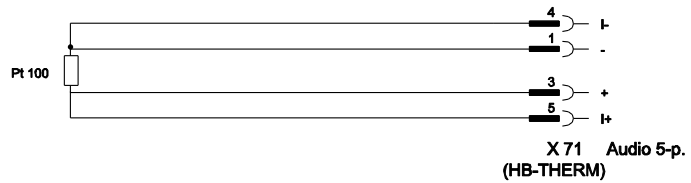

# Interface cables

## 14.2 External control



Function		Contact	Load
Unit	ON	Closing (edge)	5 VDC, 2 mA
	OFF	Opening (edge)	
Nominal value	2	Closing (edge)	5 VDC, 2 mA
	1	Opening (edge)	
Ramp programme	ON	Closing (edge)	5 VDC, 2 mA
	OFF	Opening (edge)	
Alarm contact	---	---	250 VAC, 4 A

## 14.3 Serial data interfaces

### Operation with USR type units

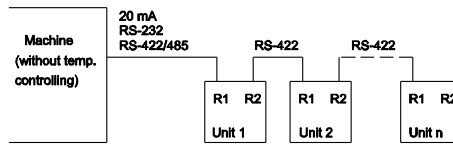

### Operation with USR and controller type units

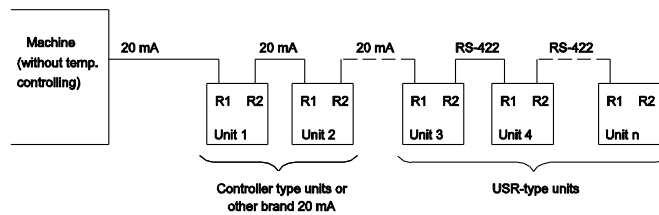

## Interface cables

### Connection cable RS-422 (between 2 USR units)

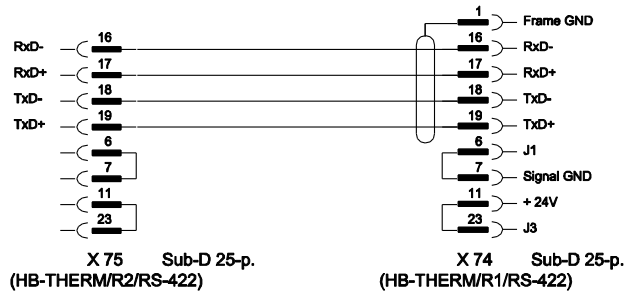

### 20 mA (current loop)

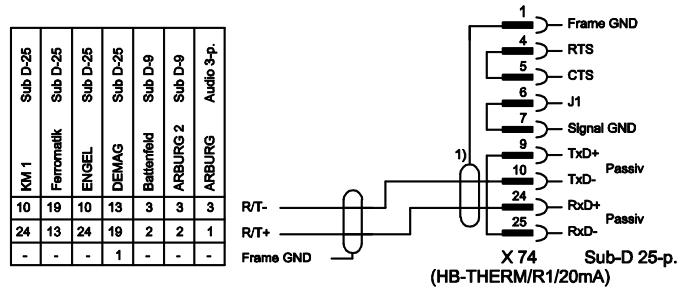

1) not applicable if shield exists on machine side

### RS-232

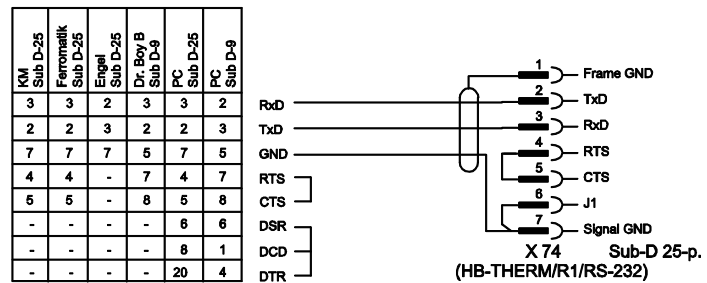

### RS-485

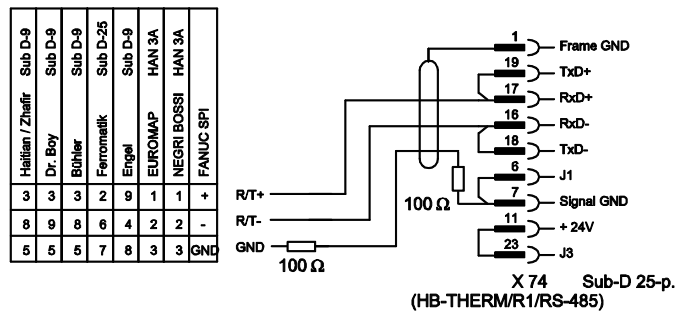



# Interface cables

## 14.4 CAN-Bus interfaces

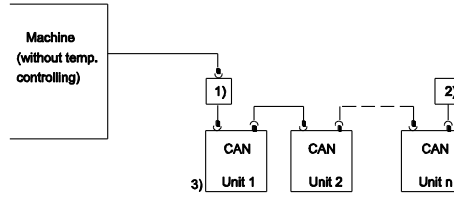

No.	Description		
1)	Adapter u/ID No. 22590 (only for DEMAG machine)		
2)	Terminator 120 Ω (not for older DEMAG machines with integrated connector)		
3)	Address	DEMAG	Unit 1 with address 13, unit 2 with address 14, etc.
		Netstal	Unit 1 with address 31, unit 2 with address 32, etc.

### Adapter

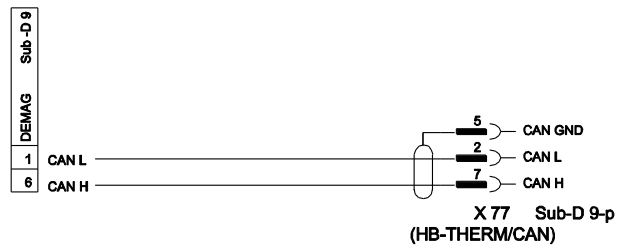

### Connection cable CAN

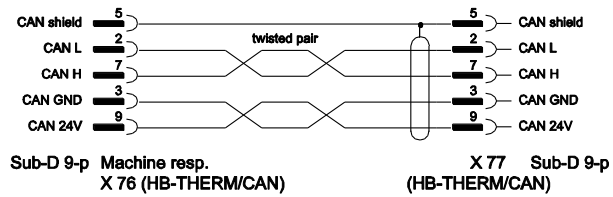

## Interface cables

### 14.5 Interface HB

#### HB

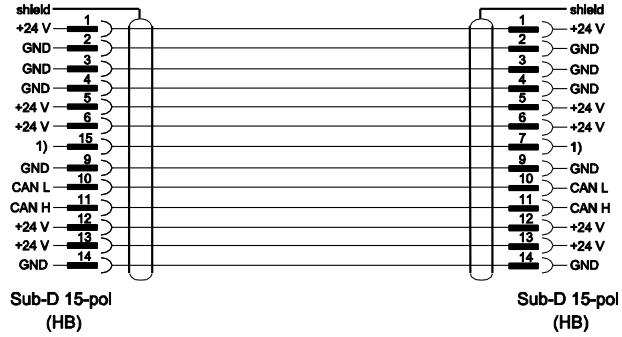

1) An automatic terminal resistance is connected over this contact.

#### HB/CAN

